

Technical Description and User Manual

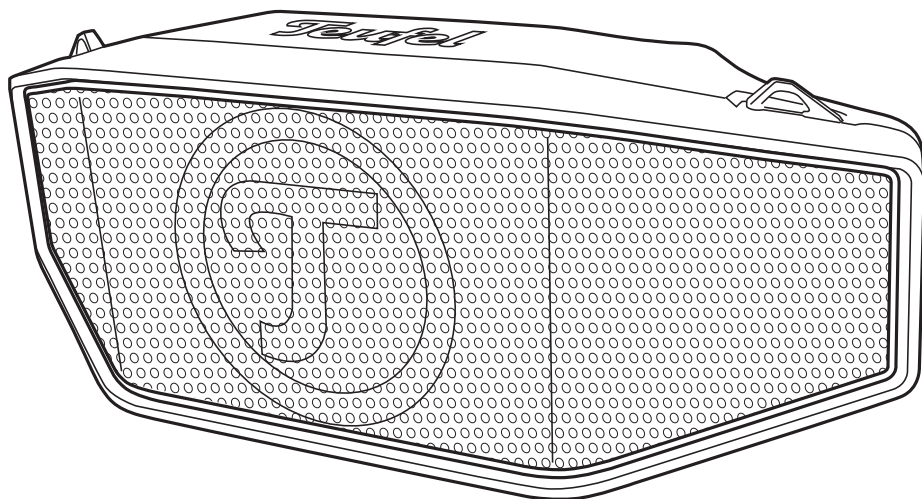

ROCKSTERCROSS

Water-resistant active Bluetooth® speaker with control for smartphone voice assistant

Teufel

Contents

For Your Safety	4	Operation	13
Proper use	4	Activating and deactivating	14
Package contents.....	8	Volume.....	14
Operational Controls And		Outdoor mode	14
Connections	8	Connect mode.....	15
The Rechargeable Battery	10	Bluetooth®	16
Charging The Rechargeable		AUX playback.....	18
Battery.....	11	Care And Cleaning.....	19
Powerbank	11	Troubleshooting.....	20
Setup.....	12	Technical Data.....	21
Location tips.....	12	Declaration of Conformity.....	21
Carrying strap.....	12		

General Notes And Information

Notice

The information in this document may change without prior notice and in no way constitutes any liability on the part of Lautsprecher Teufel GmbH.

No part of this user manual may be reproduced in any form or be broadcasted in any way electronically, mechanically, by photocopy or recording without the written permission of Lautsprecher Teufel GmbH.

© Lautsprecher Teufel GmbH

Version 1.0

December 2018

Trademarks

© All trademarks are the property of their respective owners.

 **Bluetooth**® The Bluetooth® word mark and Bluetooth® symbol are registered trademarks of Bluetooth SIG, Inc. and any use by Lautsprecher Teufel is licensed.

Qualcomm® **aptX**™ 

Qualcomm aptX is a product of Qualcomm Technologies International, Ltd.

Qualcomm is a trademark of Qualcomm Incorporated, registered in the USA and other countries, whose use

has been approved. aptX is a trademark of Qualcomm Technologies International, Ltd., registered in the USA and other countries, whose use has been approved.

Original packaging

If you wish to exercise your eight-week right of return, we ask that you be absolutely sure to hold onto the packaging. We can only accept the return of the speakers WITH THE ORIGINAL PACKAGING.

Empty boxes are not available!

Complaints

In case of a complaint we will need the following information to process your enquiry:

1. Invoice number

Can be found on the sales slip (enclosed with the product) or on the order confirmation received as a PDF document, e.g. 4322543

2. Serial number or batch number

Located on the bottom of the device, e.g. serial no.: KB20240129A-123.

Thank you for your support!

Contact

Please contact our customer service department with any questions, suggestions, or complaints:

Lautsprecher Teufel GmbH
BIKINI Berlin
Budapester Str. 44
10787 Berlin (Germany)

Telephone:
00800 200 300 40 (toll-free)

Fax:
+49 (0)30 / 300 930 930

Online support:
www.teufelaudio.com/service

Contact form:
www.teufelaudio.com/contact

For Your Safety

Proper use

The splash-proof speaker is designed for the playback of music and speech from an external player via Bluetooth® or cable.

Only use the speaker as described in this user manual. Any other use will be deemed as not in accordance with the instructions and may lead to damage of property or even persons.

The manufacturer accepts no liability for damage caused by improper use.

The speaker is intended for private use.



Before operating the speaker, please read the safety notes and user manual carefully.

Only in this way, can you ensure that all functions are used in a safe and reliable manner. Store the user manual in a safe place and also be sure to pass it on to any subsequent owner.

Signal terms

You can find the following signal terms in this user manual:

WARNING

This signal term indicates a moderate risk, which, if not avoided, may result in death or severe injury.

CAUTION

This signal term indicates a low risk, which, if not avoided, may result in minor or moderate injury.

NOTICE

This signal term warns you of potential damage.

Safety notes

This chapter contains general safety notes which you should always observe to protect yourself and third parties. Also observe the warning notes in each chapter of this user manual.

⚠ WARNING

The enclosed mains adapter is not water-resistant!

- Do not operate the mains adapter in wet rooms and protect it from dripping and splashing water. Make sure that no vases or other liquid-filled objects are located on or near the mains adapter in order to prevent liquid from penetrating the housing. If water or other foreign objects should enter the unit, immediately disconnect the mains plug. Then send the device to our service address.

⚠ WARNING

Touching live parts can result in severe injury or death.

- When connecting the mains adapter, make sure that the correct voltage is present. You can find more information about this on the rating plate.
- Regularly check the device and the mains adapter for damage. Immediately disconnect the mains plug and do not operate the device if its housing or mains cord is defective or exhibits other visible damages.
- This device can only be completely disconnected from the grid by pulling the mains adapter. Thus, make sure that the mains plug is always easily accessible.

- If the device emits smoke, smells burnt or produces unusual sounds, immediately disconnect it from the mains and do not operate it further.
- Never open the device housing. Repairs may only be carried out by an authorised specialist workshop. Only parts that match the original specifications may be used.
- Only use the enclosed mains adapter to charge the integrated rechargeable battery.
- Only use the accessory products specified by the manufacturer.
- Never modify the device. Unauthorised modifications may affect the safety and functionality.

⚠ WARNING

An unsuitable setup location may result in injury and damage.

- If the speaker is not securely mounted, do not use it in vehicles, in unstable locations, on wobbly tripods or furniture, on underdimensioned brackets etc. The speaker may tip or fall over and cause injury to persons or be damaged itself.
- Position the speaker in such a way that it cannot be knocked over inadvertently and make sure that the cables do not pose a tripping hazard.
- Do not use the device in environments where there is a risk of explosion.
- Only use the Bluetooth function in locations where wireless radio transmission is allowed.

⚠ WARNING

Lithium rechargeable batteries can explode if handled improperly.

- You must not heat or short circuit rechargeable batteries or dispose of them in fire.
- Do not expose the rechargeable batteries to direct sunlight.
- Do not place the speaker near sources of heat (e.g. heaters, ovens, other heat generating equipment such as amplifiers etc.).

⚠ WARNING

Children can become trapped in the packaging film when playing and suffocate.

- Do not allow children to play with the device or the plastic wrapping. There is a danger of suffocation.
- Never allow children to operate electrical equipment unsupervised.

⚠ CAUTION



Extended listening at high volumes may lead to hearing loss.

To avoid damage to health, avoid extended listening at high volumes.

- To avoid damage to health, avoid extended listening at high volumes.
- When the volume is set high, always keep a certain distance from the device and never place your ears directly on the speaker.

- If a speaker is set to full volume, this may produce very high sound pressure. This may have psychological consequences and also cause physical injury. Children and pets are particularly at risk. Set the volume control of your external player to low volume before you turn it on.

⚠ CAUTION

This product contains magnetic material.

- If necessary, consult your physician and ask for effects on implants such as pacemakers or defibrillators.

NOTICE

The ROCKSTER CROSS is splash-proof but not watertight!

- The splash-proof protection is only effective if the rubber caps on the connections seal them off properly.
- Normal rain and a few water splashes won't cause any damage, but you should avoid spraying it directly with a hose.

NOTICE

Gross misuse and incorrect care are the main reasons for damage to high-performance rechargeable batteries.

- Avoid deep discharge of under 20 % for optimal rechargeable battery power.
- Recharge your rechargeable battery frequently.

- Store your rechargeable battery in a cool, but frost-free area, ideally at 15 °C. Higher temperatures result in a higher rate of self-discharge and shorten the intervals between charges.
- Do not expose the rechargeable battery to direct sunlight or other sources of heat.
- A deep discharge damages the rechargeable battery cells. The most frequent cause of deep discharge is prolonged storage or failure to use a partially discharged rechargeable battery. Only store the rechargeable battery once it is fully charged.



Old devices must not be disposed of with household waste!

■ If the ROCKSTER CROSS is no longer operational, every consumer is required by law to dispose of used devices separately from household waste, e.g. at a collection point run by the communal authority/borough. This ensures that old devices are recycled in a professional manner and also rules out negative consequences for the environment.

For this reason, electrical equipment is marked with the adjacent symbol.



Rechargeable batteries must not be disposed of with household waste!

Every consumer is required by law to bring all batteries and rechargeable batteries to a collection point run by the communal authority/borough or to a retailer, so that they can be disposed of in an environmentally friendly manner.

Please only turn in batteries and rechargeable batteries which are empty!

Package contents





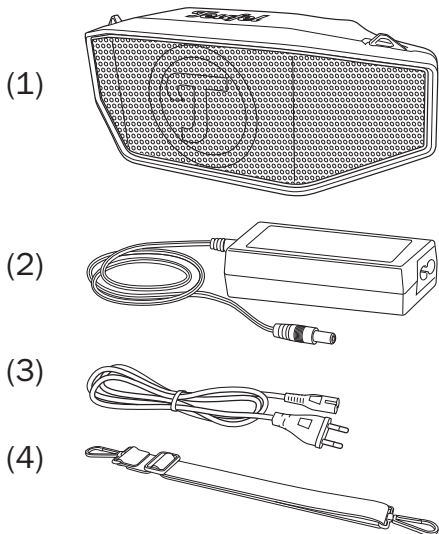



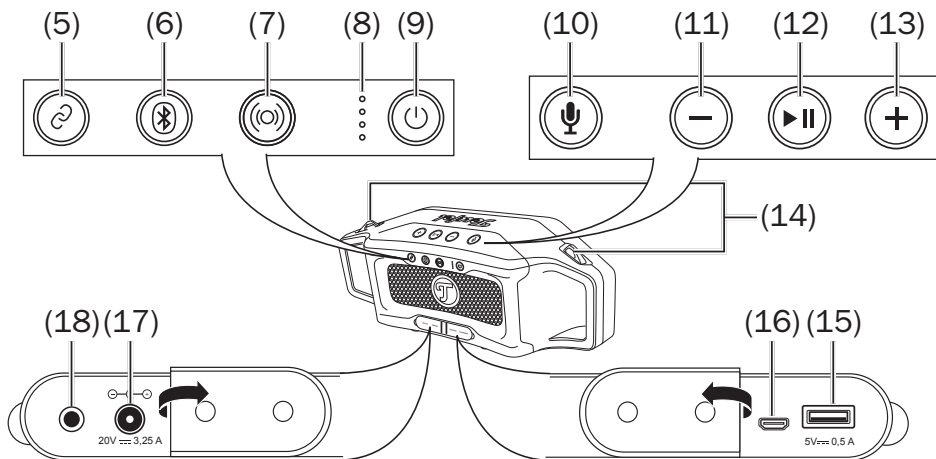

- (1) ROCKSTER CROSS
- (2) Mains adapter
- (3) Mains cord for mains adapter **(2)**
- (4) Carrying strap

- Check that all items have been delivered and that nothing is damaged. If you find any damage, do not operate the device; instead contact our customer service department (see „Contact“ on page 3).
- Please keep the packaging for the duration of the warranty period.



Operational Controls And Connections



- (5)** Push and hold  for 3 seconds: Enable and disable connect mode (see page 14).
- (6)** Push and hold  for 3 seconds: Start Bluetooth pairing mode. Push and hold  for 10 seconds: Clear all saved Bluetooth connections.
- (7)**  Enable and disable outdoor mode (see page 14).
- (8)** LED indicator for charging and rechargeable battery charge level.
- (9)** Push and hold  for 2 seconds: Switch the device on, the button will be illuminated in red. Tap  during operation: Display battery charge with LEDs **(8)**. Push and hold  for 2 seconds: Switch the device off.
- (10)** Only with Bluetooth playback:  Tap: Enable the smartphone's voice assistant. Tap  for a phone call: Accept call/hang up.
- (11)** – Reduce the volume. In case of an incoming call: Reject call. In case of BT playback push together with button **(12)**: Skip back.
- (12)**  Playback/pause. Tap in case of a phone call: Accept call/hang up.
- (13)** + Increase the volume. In case of BT playback push together with button **(12)**: Skip forward.
- (14)** Loops for carrying strap **(4)**.
- (15)** USB port for the power supply of external players such as MP3 players or smartphones (type A, 5 V, 0.5 A). Data transmission is not possible. Please note that charging a device may reduce the rechargeable battery life of your ROCKSTER CROSS.
- (16)** USB micro port for service.
- (17)** Mains adapter connection.
- (18)** AUX IN, stereo input with a 3.5 mm jack plug socket.

The Rechargeable Battery

You can operate the ROCKSTER CROSS via the enclosed mains adapter or the integrated rechargeable battery.

- Before first use, charge the rechargeable battery for approx. 3 to 4 hours.

CAUTION

Batteries (particularly lithium batteries) can explode if used improperly.

- You must not heat or short circuit rechargeable batteries or dispose of them in fire.
- Do not expose the rechargeable batteries to direct sunlight.
- Only use the enclosed mains adapter for charging.

The integrated lithium ion rechargeable battery provides up to 20 hours of operating time – regardless of the volume and the amount of bass in the tracks played.

Thanks to the Powerbank function, you can charge another device (e.g. smartphone) via the CHARGING USB jack (15).

Please observe the maximum charging current of 0.5 A and that charging an external device reduces the operating time.

Rechargeable battery charge level

You can display the rechargeable battery charge level by tapping the  button (9).

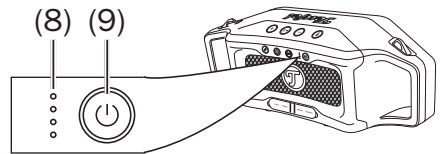

76-100%	all 4 LEDs are illuminated
51-75%	3 LEDs are illuminated
26-50%	2 LEDs are illuminated
11-25%	1 LED is illuminated
<10%	Bottom LED is flashing

To protect the rechargeable battery, the ROCKSTER CROSS has deep discharge protection, which switches the device off once the threshold is reached.

 If the rechargeable battery charge diminishes, the ROCKSTER CROSS will emit two short warning tones several times and the LED at the bottom of the rechargeable battery indicator (8) will blink. Depending on the volume, operation will still be possible for up to 60 minutes.

In this case, connect the mains adapter as soon as possible.

Charging The Rechargeable Battery

The integrated Li-Ion rechargeable battery is charged as soon as the ROCKSTER CROSS is supplied with power from the mains adapter (2). Connect the small plug of the mains adapter to the POWER jack (17) and connect the mains adapter to a socket (100–240 V~, 50/60 Hz) via the mains cord (3).

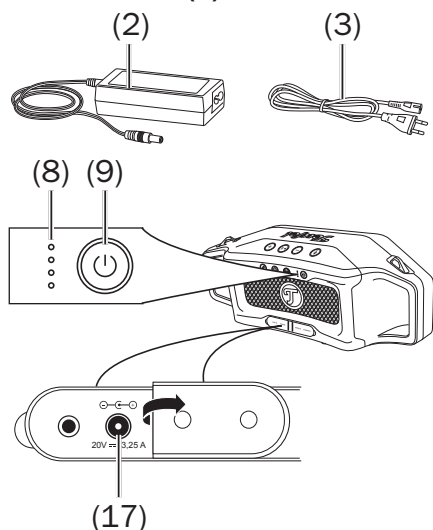

Four white LEDs on the rechargeable battery indicator (8) signalise the charging process:

100%	all 4 LEDs are illuminated
75-99%	3 LEDs are illuminated, 4th is flashing
50-74%	2 LEDs are illuminated, 3rd is flashing
25-49%	1 LED is illuminated, 2nd is flashing
<25%	Bottom LED is flashing

Powerbank

You can charge an external player (e.g. smartphone) via the CHARGING USB jack (15).

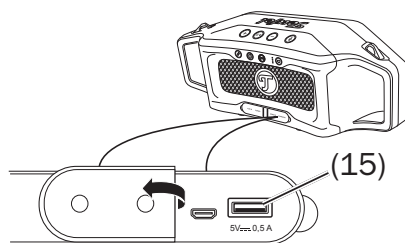

- The max. charging current amounts to 0.5 amps.

The charging process is also continued when you switch the ROCKSTER CROSS off or it switches to standby after not being used.

NOTICE

In battery mode, charging an external player reduces the operating time of the ROCKSTER CROSS.

Setup

Location tips

- Select a stable, level base.
- Select a location away from heat sources and direct sunlight.
- If applicable, lay the connector cords so that they do not pose a tripping hazard.
- Do not place any heavy objects on the ROCKSTER CROSS.

You can also tilt the ROCKSTER CROSS back slightly so that it projects sound at an upwards-facing angle. In the process, make sure that no plugs (USB, mains adapter) are clamped in.

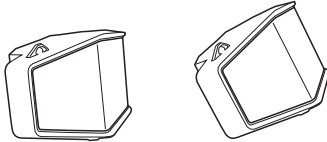

NOTICE

On flat surfaces (e.g. table or dresser), the device may move and even fall down if set up in an inclined position and when playing loud music.

- Only set up the device on the ground in an inclined position.

Carrying strap

You can hang the ROCKSTER CROSS around your shoulders like a bag with the carrying strap (4).

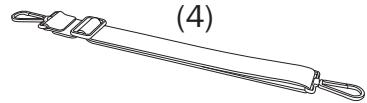

Secure the snap hooks of the strap on the two loops (14) of the ROCKSTER CROSS.

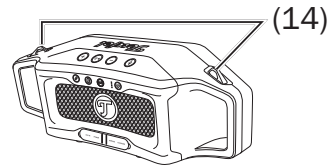

NOTICE

Plugs, which may be connected to the ports (15)-(18), can be damaged or damage the device in the process.

- Only use the carrying strap if no plugs are connected to the ROCKSTER CROSS.

Operation

CAUTION



Extended listening at high volumes may lead to hearing loss.

- *To avoid damage to health, avoid extended listening at high volumes.*
- *When the volume is set high, always keep a certain distance from the device and never place your ears directly on the speaker.*
- *If a speaker is set to full volume, this may produce very high sound pressure. This may have psychological consequences and also cause physical injury. Children and pets are particularly at risk. Set your signal source device volume control to a low setting before turning on the power.*

NOTICE

If the device is subjected to warm temperatures after being cold (e.g. after transport), condensation may occur inside of it.

- *In this case, wait at least 2 hours before you connect and activate it.*

Activating and deactivating

Activating

- Push and hold the  button (9) for approx. 2 seconds. The ROCKSTER CROSS will switch on and the ring around the button will be illuminated in red.

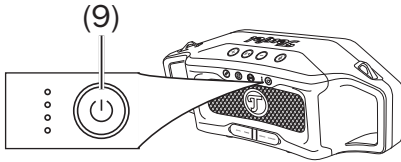



Deactivating

- Push and hold the  button (9) for approx. 2 seconds. The ROCKSTER CROSS will switch off.

Auto off

- The device will automatically switch to standby if no input signal is received for 10 minutes. Turning the device on is then only possible by pressing the  button (9) on the back of it.

Volume

- With the  (11) and  buttons (13), you can reduce or increase the volume.

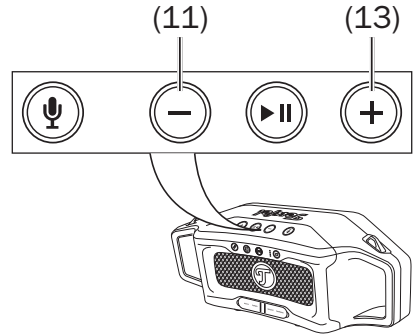

You can gradually adjust the volume by tapping. Pushing and holding will change the volume continuously.

Outdoor mode

Outdoor mode is a technology for improving the listening experience outside in loud and uncontrolled surroundings.

This is achieved by compensating certain frequencies. You can switch outdoor mode on and off with the button  (7).

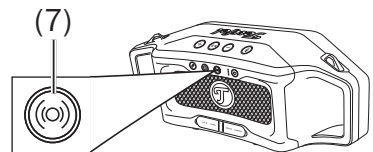

Connect mode

You can pair the ROCKSTER CROSS with compatible devices via Bluetooth so both devices play the same music. This only works with the ROCKSTER CROSS and the ROCKSTER GO. When pairing, both devices must be placed directly next to each other.

However, then the distance between the paired devices can be up to 5 meters.

Thus, you can use two devices at the same time to supply a larger area with sound.

1. Push and hold the  button **(5)** for approx. 3 seconds.

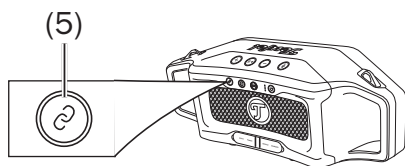

Pairing has started and the ring around the button pulses in white.

2. Start pairing on the second device (refer to the user manual for the other device).

After a short time, the two devices will connect with one another.

On the ROCKSTER CROSS, the ring around the button  **(5)** will now light up continuously in white and a tone will sound signaling connection.

Both devices will now play the same music.

- Control playback on the ROCKSTER CROSS.

- Push and hold the  button **(5)** for approx. 3 seconds to disable the connect mode.

The ring around the button will go out and the connection will end.

Bluetooth®

Via Bluetooth®, you can establish a wireless connection between a compatible external player (e.g. smartphone) and the ROCKSTER CROSS. The audio output of your external player is then emitted by the ROCKSTER CROSS.

You can also register two Bluetooth devices and have them played in alternation.

For smartphones with Android or an IOS operating system, you can also use the voice assistant via the ROCKSTER CROSS.

NOTICE

Only use the Bluetooth® function in locations where wireless radio transmission is allowed.

Bluetooth® options

Depending on the device type and operating system, your external player/smartphone may also have a number of Bluetooth® options such as media playback and call function. Here you can activate and deactivate the desired options.

You can find more information about the Bluetooth® options in the user manual for your external player/smartphone.

Pairing

To play the audio of your external player on your ROCKSTER CROSS via Bluetooth®, you must first connect the devices with each other. This is called “Pairing”. The ROCKSTER CROSS can save data from up to seven external players, which can be subsequently connected to without having to repeat the pairing process.

1. Turn on the Bluetooth® function on your external player.
2. Push and hold the  button **(6)** for approx. 3 seconds.

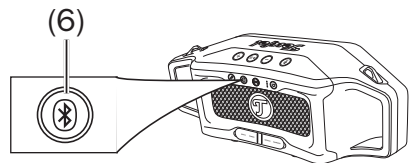

You will hear a short signal tone and the ring around the button will be illuminated in blue.

3. Let your external player/smartphone scan for Bluetooth® devices. You will find more information about this in the user manual of your external player. After the search run, the “Teufel ROCKSTER CROSS” should also be present in the list of detected devices.
4. Select “Teufel ROCKSTER CROSS” from the list of detected devices. Pairing is now complete and your ROCKSTER CROSS will now act as a Bluetooth® playback device. The ROCKSTER CROSS will now play

back all sounds that would otherwise be played by your external player/smartphone.

5. If you would like to pair a second external player, repeat steps 1 to 4 with the second device. You can then select the Teufel ROCKSTER CROSS from the list of paired devices on the first device. Now you can use both devices in party mode in alternation (see chapter “Party mode”).

Playback

i The volume setting of the external player affects the volume of the ROCKSTER CROSS.

- Start playback on your external player.
- Pause playback:
Briefly push the button ►|| (12).
- Continue playback:
Briefly push the button ►|| (12).
- Play next track:
Tap the buttons ►|| (12) and + (13) at the same time.
- Start the track from the beginning:
Tap the buttons ►|| (12) and – (11) at the same time.
- Play previous track:
Tap the buttons ►|| (12) and – (13) twice at the same time.

Party mode

If you are using two external players at the same time, you can look for the next track on one device while the other is playing. Once the track is over, push the stop or pause button and start playback on the other device.

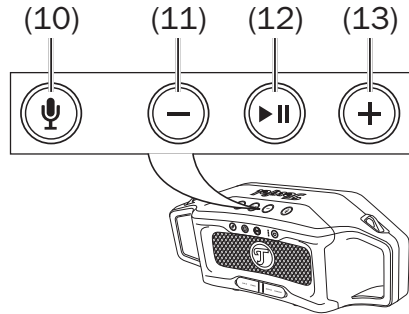

Voice assistants

Prerequisites: Present Bluetooth connection and voice assistant on the smartphone is enabled.

To activate the assistant, tap the **🎤** button (7) and wait until the assistant responds. Then simply speak in the direction of the ROCKSTER CROSS. The volume when playing back voice and signal tones related to the voice assistant depends on the settings of your smartphone. If the output of voice or tones is too loud or too quiet, please refer to the manual of your smartphone.

Call function

You can use the ROCKSTER CROSS as a hands-free device for your smartphone.

- In the event of an incoming call, your smartphone will ring and the ROCKSTER CROSS will also emit the ring tone. Any media playback will be paused.
- To reject the call, tap the – button **(13)**. The call will be ended and the caller will hear the busy signal.
- To take the call, tap the button **ψ (10)** or **▶ II (12)** on the ROCKSTER CROSS.
- Now you can answer the call with your ROCKSTER CROSS via the integrated microphone.
- Push the button **ψ 18** or **▶ II (12)** again to end the call.

Media playback will resume.

The volume when playing back voice and signal tones related to the voice assistant depends on the settings of your smartphone. If the output of voice or tones is too loud or too quiet, please refer to the manual of your smartphone.

Terminating the Bluetooth connection

To terminate the Bluetooth® connection, switch the Bluetooth® function on your external player/smartphone off.

- To delete the list of known external players, hold the **Bluetooth (6)** button down for approx. 10 seconds until two short signal tones can be heard.

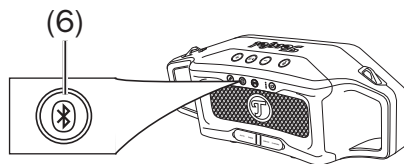

AUX playback

Connection

The AUX IN jack **(18)** serves to connect an external player using a stereo cable with a 3.5 mm jack plug. You can connect any external players with a line-out jack or headphone jack.

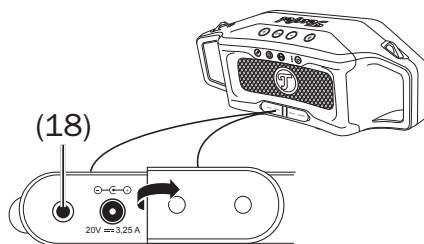

Playback

1. If applicable, stop playback from a Bluetooth device.
2. Start playback on your external AUX player.
3. Control all playback functions via the external player.

i The volume setting of the external player affects the volume of the ROCKSTER CROSS.

Care And Cleaning

NOTICE

External influences may damage or destroy the device.

- *If the device is to be left unattended for a prolonged period of time (e.g. during a vacation) or if a thunderstorm is forecast, pull the mains plug out of the socket. Otherwise, sudden overvoltage could cause the device to become defective.*
 - *If possible, only use plain water without any additives. In case of stubborn marks, a mild soap solution may be used.*
 - *Do not use caustic cleaning products, white spirit, thinners, petrol or similar under any circumstances. Such cleaning agents may damage the delicate surface of the housing.*
- Ideally, you should remove dust or small amounts of dirt with a dry, smooth leather cloth.
 - Use a damp cloth to rub off stubborn dirt. Make sure that no liquid penetrates the housing.
 - Then immediately wipe the damp surfaces off with a soft cloth without applying pressure.

Troubleshooting

The following advice should help you to solve problems. If this does not work, our online manual will provide help:

<https://manual.teufelaudio.com>

Problem	Possible cause/solution
The ROCKSTER CROSS doesn't emit sound.	The rechargeable battery is empty. Connect the mains adapter and charge the rechargeable battery.
No sound.	The volume has been set too low. Increase the volume.
	The volume of the external player has been set too low. Carefully increase the volume of the external player.
No sound with Bluetooth®.	No Bluetooth® connection. Establish a connection (see "Bluetooth®" on page 16).
	ROCKSTER CROSS has not been selected as the output device. On the external player, select "Teufel ROCKSTER CROSS" as the Bluetooth® output device.
	Bluetooth® connection impaired by another radio system (e.g. cordless telephone, Wi-Fi). Move the devices causing the disturbance.
Playback is noisy.	Generally speaking, the ROCKSTER CROSS is a very low-noise system. The speaker system with very high resolution in the high range area can expose the poor quality of a signal source (e.g. from MP3 files). Ensure that the source is sending a clear signal to the ROCKSTER CROSS.
The voice assistant doesn't work.	Activate the voice assistant on the smartphone.

Technical Data

Operating voltage of the mains adapter	100–240 V~, 50/60 Hz
Power consumption of the mains adapter max.	1.5 A
Dimensions (W×H×D)	385 × 149 × 129 mm
Weight	2,820 g

The following radio frequency bands and radio transmitting powers are used in this product:

Frequency bands	Max. transmission power
2.4-2.4835 GHz	2.5 mW/4 dBm

You can find further technical data about the product on our website.

Declaration of Conformity



Lautsprecher Teufel GmbH hereby declares that this product complies with the requirements of the directives 2014/30/EU, 2014/35/EU and 2014/53/EU to the extent they are installed and used in accordance with the instructions of the manufacturer. The full text of the EU declaration of conformity is available at the following Internet address:

www.teufelaudio.com/declaration-of-conformity.html

Teufel

Please contact our customer service department with any questions, suggestions, or complaints:

Lautsprecher Teufel GmbH

BIKINI Berlin

Budapester Str. 44

10787 Berlin (Germany)

Telephone: 00800 200 300 40 (toll-free)

Fax: +49 (0)30 / 300 930 930

Online support: www.teufelaudio.com/service

Contact form: www.teufelaudio.com/contact

No responsibility is assumed for the correctness of this information.
Technical changes, typographical errors and other errors reserved.