

# Technical Description And User Manual

---

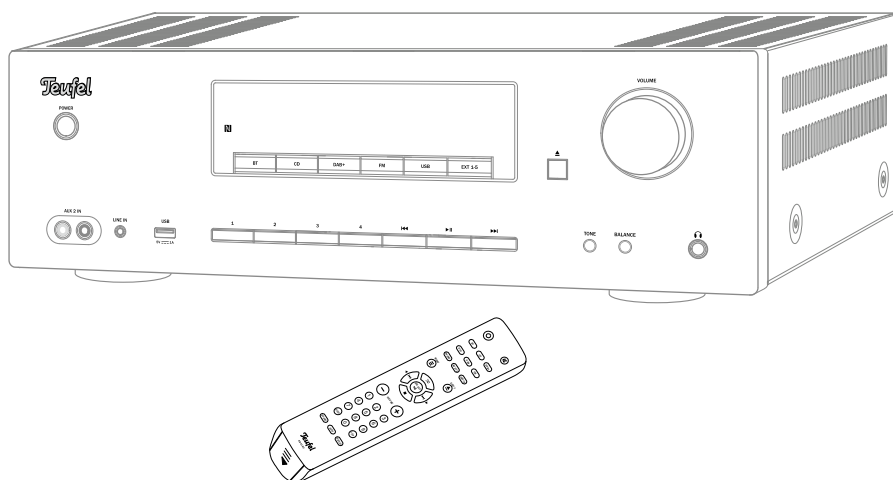

## **KB 62 CR**

2.1 CD receiver with DAB+ and Bluetooth®

# **Teufel**

# Contents

---

<b>General Notes And Information</b> .....	<b>3</b>	<b>Radio Mode</b> .....	<b>23</b>
<b>For Your Safety</b> .....	<b>6</b>	FM.....	23
<b>Overview</b> .....	<b>9</b>	DAB/DAB+ .....	24
<b>Control Elements And</b>		Station memory.....	25
<b>Connections</b> .....	<b>10</b>	<b>Bluetooth® Mode</b> .....	<b>26</b>
<b>Remote Control</b> .....	<b>12</b>	Bluetooth® options.....	26
<b>Setup And Connection</b> .....	<b>14</b>	Pairing.....	27
Location tips.....	14	Manual pairing.....	27
Antenna .....	14	Pairing via NFC® .....	28
Inputs for source devices .....	15	Restoring the connection	
Speaker outputs.....	15	with a paired external player... 28	
Subwoofer .....	16	Interruption of connection .....	28
REC OUT .....	16	Playback.....	29
Headphones.....	16	Terminating the connection .... 29	
Mains connection .....	17	<b>CD Mode</b> .....	<b>30</b>
<b>Basic Functions</b> .....	<b>18</b>	Disc playback .....	31
Activating and deactivating .....	18	Ejecting the disc.....	32
Selecting a source .....	18	<b>USB Mode</b> .....	<b>33</b>
Adjusting the volume .....	19	Connecting and playing	
Adjusting the sound .....	19	back a USB device .....	33
Adjusting the balance .....	20	Removing the USB device .....	35
Crossover frequency .....	21	<b>Sleep Function</b> .....	<b>36</b>
Menu.....	21	<b>Care And Cleaning</b> .....	<b>37</b>
Adjusting the display		<b>Troubleshooting</b> .....	<b>38</b>
brightness .....	22	<b>Index</b> .....	<b>40</b>
Resetting the KB 62 CR		<b>Technical Data</b> .....	<b>42</b>
to the default settings .....	22	<b>Declaration of Conformity</b> .....	<b>42</b>
Loading new system software .. 22			
Accessing the version of			
the system software. ....	22		
Leaving the menu .....	22		

# General Notes And Information

---

## Notice

The information in this document may change without prior notice and in no way constitutes any liability on the part of Lautsprecher Teufel GmbH.

No part of these instructions may be reproduced in any form or be broadcasted in any way electronically, mechanically, by photocopy or recording without the written permission of Lautsprecher Teufel GmbH.

© Lautsprecher Teufel GmbH

Version 2.1

November 2017

## Trademarks

© All trademarks are the property of their respective owners.

 **Bluetooth**<sup>®</sup> Bluetooth<sup>®</sup> and the Bluetooth symbol are trademarks of Bluetooth SIG, Inc.

 The “N-Mark” symbol is a trademark or registered trademark of NFC Forum, Inc. in the USA and other countries.

**Qualcomm<sup>®</sup> aptX<sup>™</sup>** 

Qualcomm aptX is a product of Qualcomm Technologies International, Ltd.

Qualcomm is a trademark of Qualcomm Incorporated, which is registered in the USA and other countries; its use has been approved. aptX is a trademark of Qualcomm Technologies International, Ltd., which is registered in the USA and other countries; its use has been approved.

## Original packaging

If you wish to exercise your eight-week right of return, we ask that you be absolutely sure to hold onto the packaging. We can only accept the return of the speakers WITH THE ORIGINAL PACKAGING.

Empty boxes are not available!

## Complaints

In case of a complaint we will need the following information to process your enquiry:

### 1. Invoice number

Can be found on the sales slip (enclosed with the product) or on the order confirmation received as a PDF document, e.g. 4322543

### 2. Serial number or batch number

Located on the back of the device, e.g. serial no.: KB20240129A-123.

Thank-you for your support!

## Contact

Please contact our customer service with any questions, suggestions or criticism:

**Lautsprecher Teufel GmbH**

**BIKINI Berlin**

**Budapester Str. 44**

**10787 Berlin (Germany)**

Phone 00800 - 200 300 40 (toll-free)

Fax: +49 (0)30 / 300 930 930

Service:

[www.teufelaudio.com/service](http://www.teufelaudio.com/service)

Contact:

[www.teufelaudio.com/contact](http://www.teufelaudio.com/contact)

## Proper use

The KB 62 CR is designed for the playback of music and speech via FM/DAB+ radio, CD, USB, Bluetooth or an external player.

Only use the device as described in this user manual. Any other use will be deemed as not in accordance with the instructions and may lead to damage of property or even persons.

The manufacturer accepts no liability for damage caused by improper use.





The device is intended for private use only.



Before operating the device, please read the safety notes and user manual carefully.

This is the only way to use all functions safely and reliably. Store the user manual in a safe place and also be sure to pass it on to any subsequent owner.

## Explanation of symbols

	<p>Protection class II Dual insulation</p>
	<p>Risk of electrical shock Do not open the housing.</p>
 	<p><b>Old devices must not be disposed of with household waste!</b></p> <p>If the device is no longer operational, every consumer is required by law to dispose of old devices separately from household waste, e.g. at a collection point run by the communal authority/borough. This ensures that old devices are recycled in a professional manner and also rules out negative consequences for the environment.</p> <p>For this reason, electrical equipment is marked with the adjacent symbol.</p>

	<p><b>Batteries and rechargeable batteries do not belong in the household garbage!</b></p> <p>Every consumer is required by law to bring all batteries and rechargeable batteries, regardless whether they contain harmful substances*) or not, to a collection point run by the communal authority or borough or to a retailer, so that they can be disposed of in an environmentally friendly manner.</p> <p>Please only turn in batteries and rechargeable batteries which are empty!</p> <p>*) labelled with: Cd = cadmium, Hg = mercury, Pb = lead</p>
---	---

# For Your Safety

---

## Signal terms

You can find the following signal terms in this user manual:

### CAUTION

**This signal term indicates a low risk, which, if not avoided, may result in minor or moderate injury.**

### NOTICE

**This signal term warns you of potential damage to property.**

## Safety notes

**Improper electrical installation or excessive mains voltage may result in an electrical shock.**

- The device is suitable for a mains voltage of 230 V, 50 Hz. When connecting the device, make sure that the correct voltage is present. You can find more information about this on the rating plate.
- Check the device regularly for damage. Immediately disconnect the mains plug and do not operate the device if its housing, mains adapter or mains cord is defective or exhibits other visible damages.
- If the mains cord is damaged, replace it with an equivalent one.
- Make sure that the mains plug is always easily accessible.
- If the device emits smoke, smells burnt or produces unusual sounds, immediately disconnect it from the mains and do not operate it further.
- Never open the device housing. Repairs may only be carried out by an authorised specialist workshop. Only parts that match the original specifications may be used.
- Only use the accessory products specified by the manufacturer.
- Only use the device indoors.
- Do not operate the device in wet rooms and protect it from dripping and splashing water. Make sure that no vases or other liquid-filled objects are located on or near the device in order to prevent liquid from penetrating the housing. If water or any foreign objects have entered the housing, immediately disconnect the mains plug and send the device to our service address.
- Never modify the device. Unauthorised modifications may affect the safety and functionality.
- Never touch the mains plug with wet hands.

**An unsuitable setup location may result in injury and damage.**

- Never use the device unmounted in vehicles, in unstable locations, on wobbly tripods or furniture, on insufficiently dimensioned brackets etc. The device could tip or fall down and cause injury to persons or be damaged itself.
- Arrange the device so that it cannot be knocked over accidentally and make sure that the cables do not pose a trip hazard.
- Do not place the device near heat sources (e.g. heaters, ovens, other heat generating equipment such as amplifiers etc.).
- Do not use the device in environments where there is a risk of explosion.
- Only use the Bluetooth® function in locations where wireless radio transmission is allowed.

**Children can become trapped in the plastic wrapping when playing and suffocate.**

- Do not allow children to play with the device or the plastic wrapping. There is a danger of suffocation.
- Ensure that children do not remove small parts from the device or take them off of the device (e.g. control knobs or plug adapters). They could swallow the parts and choke.
- Never allow children to operate electrical equipment unsupervised.



**Extended listening at high volumes may lead to hearing loss.**

To avoid damage to health, avoid extended listening at high volumes.

- When the volume is set high, always keep a certain distance from the device and never place your ear directly on the speaker.
- If a device is set to full volume, this may produce very high sound pressure. This may have psychic consequences and also cause physical injury. Children and pets are particularly at risk. Set the volume control to a low setting before you turn the device on.



**Operating the device when the housing is open will cause an invisible or visible laser beam to be emitted.**

- Do not look into the beam, even if you are using optical instruments.

**This product contains magnetic material.**

- If necessary, consult your physician and ask for effects on implants such as pacemakers or defibrillators.

**If the device is subjected to warm temperatures after being cold (e.g. after transport), condensation may occur inside of it.**

- In this case, wait at least 2 hours before you connect and activate it.

**Improper use may lead to damage or fire.**

- Do not place open flames such as burning candles or similar on the device.
- Ensure sufficient ventilation.
- Do not place the device in direct sunlight.
- Only use the device in indoor areas.



# Overview

---

## Unpacking

- Carefully open the box and carefully lift the KB 62 CR with the EPE foam parts out.

## Pack contents

- ① 1× CD receiver KB 62 CR
- ② 1× remote control KB 62 RC
- ③ 1× mains cord for ①
- ④ 2× LR03/micro battery for ②
- ⑤ 1× throw-out antenna DAB+/FM
- ⑥ 1× antenna adapter
- ⑦ 2× speaker cable

## Checking the product contents

- Check that all items have been delivered and that nothing is damaged.
- If the delivery is incomplete or has been damaged, please contact our service team (see “„Contact“ on page 4).

## NOTICE

- *Do not operate the device if it is damaged.*

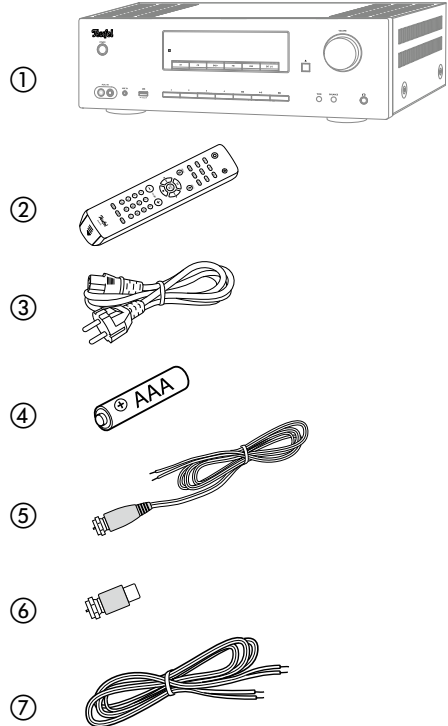

# Control Elements And Connections

## Front side

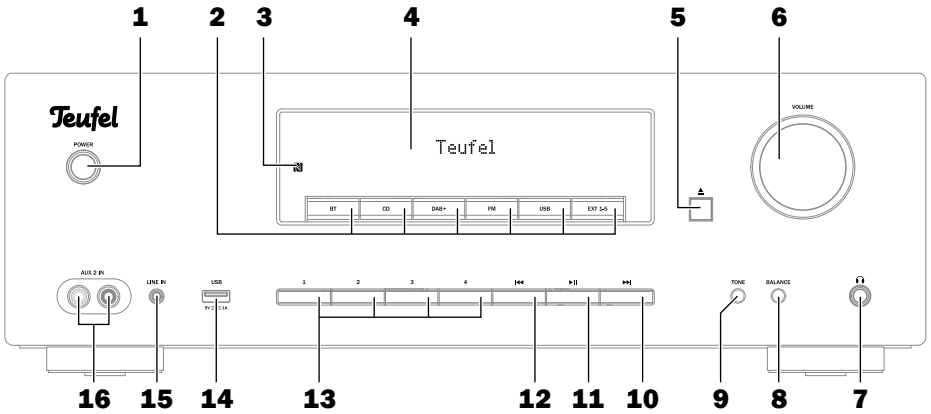

## Back side

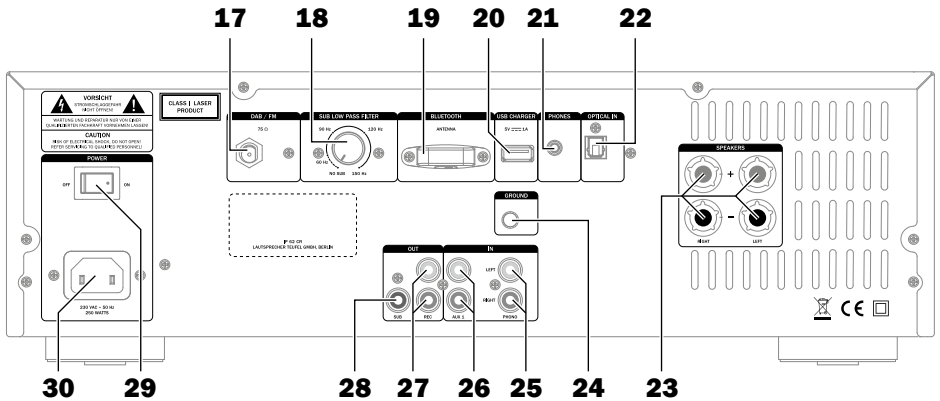

- 1 Power/standby button
- 2 CD compartment and buttons for selecting the source:  
Press: Select a source  
Press and hold: Source-dependent function
- 3 NFC pairing point for Bluetooth
- 4 DISPLAY
- 5 Open/close the CD compartment, eject USB
- 6 Adjust the volume,  
Push: Mute speaker (mute)
- 7 Jack for headphones
- 8 Adjusting the balance
- 9 Adjust the sound
- 10 CD/USB: next track, fast forward. DAB+/FM: Increase the frequency, station scan
- 11 Start/pause playback
- 12 CD/USB: Restart track, previous track, fast rewind. DAB+/FM: Decrease the frequency.
- 13 Station buttons
- 14 USB port
- 15 LINE IN input jack
- 16 AUX-2 input jacks
- 17 Antenna connection
- 18 Set the crossover frequency for the sub
- 19 Bluetooth antenna
- 20 Charging port for USB devices
- 21 Port for headphones
- 22 Optical digital input
- 23 Speaker terminals
- 24 Ground connection for phono
- 25 Phono input jacks
- 26 AUX 1 input jacks
- 27 REC output jacks
- 28 Connection for active subwoofer
- 29 Turn the device on/off
- 30 Jack for mains cord ③

# Remote Control

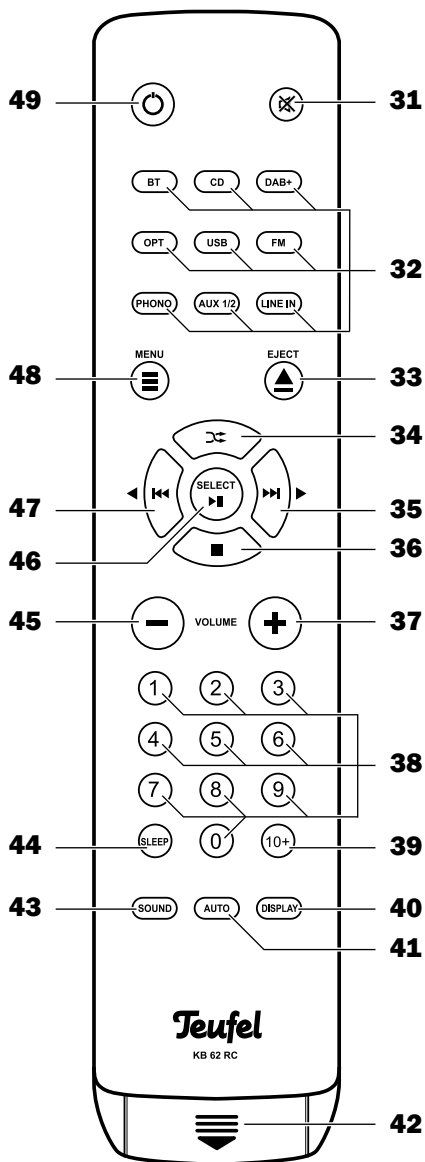

- 31** Mute speaker (mute)
- 32** Press: Select a source  
Press and hold: Source-dependent function
- 33** Open/close the CD compartment, eject USB
- 34** CD + USB: Random playback
- 35** Right,  
CD + USB: Press: Skip,  
Press and hold: Fast forward  
Radio: Setting a station
- 36** CD + USB: Stop
- 37** Increase the volume
- 38** Number buttons
- 39** Enter numbers >9
- 40** Switch the display
- 41** Start the automatic station programming
- 42** Battery compartment cover
- 43** Adjust the sound/balance
- 44** Set the sleep time
- 45** Reduce the volume
- 46** Selector button, start/pause playback
- 47** Left,  
CD + USB: Press: Skip,  
Press and hold: Fast rewind  
Radio: Setting a station
- 48** Display menu
- 49** Power on/Standby

## CAUTION

**Leaking battery acid may lead to chemical burns.**

- *Store both new and used batteries so that they are not accessible to children.*
- *Do not allow battery acid to come into contact with skin, eyes or mucous membranes. In the event of contact with battery acid, immediately flush the applicable areas with plenty of clean water and consult a physician if necessary.*

**Batteries (particularly lithium batteries) can explode if used improperly.**

- *Never attempt to recharge batteries.*
- *Only use batteries of the same or equivalent type.*
- *Never heat or short circuit batteries or rechargeable batteries, or dispose of them in fire.*
- *Do not expose batteries and rechargeable batteries to direct sunlight.*

In order to operate the remote control, you will need two type AAA or micro batteries with 1.5 Volt (included in the pack contents).

You should change the batteries if the remote control stops working properly or after 2 years at the latest.

## **Inserting batteries**

1. Gently push the battery compartment cover **(42)** in the direction of the arrow until it pops open.
2. If applicable, remove any old batteries (please observe the disposal notes on page 5).
3. Insert the new batteries according to the image on the battery compartment; make sure the polarity is correct.

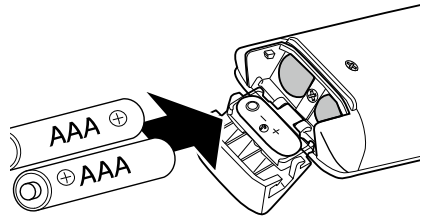

4. Put the cover back in place and push it closed.

## **Functionality**

The remote control relays the control signals by means of infrared light. For this, you will have to point the front of the remote control towards the KB 62 CR. Make sure that the infrared light is not obstructed by objects.

# Setup And Connection

## NOTICE

If the device is subjected to warm temperatures after being cold (e.g. after transport), condensation may occur inside of it.

- In this case, wait approx. 2 hours before you connect and activate it.

## Location tips

- Select a stable, level base.
- Make sure that the environment is clean and free from dust.
- Select a location away from heat sources and direct sunlight.
- The device should have approx. 10 cm of clearance on all sides to ensure adequate circulation of air.
- Do not place any heavy objects on the cables or the device.

## ⚠ CAUTION

### Risk of injury/damage!

- Lay the cables so that they do not pose a tripping hazard.

## Antenna

You can use the enclosed throw-out antenna ⑤ to receive DAB+ and FM at the same time.

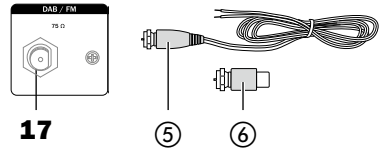

1. Insert the antenna in the DAB/FM jack (**17**) and screw the union nut tight.
2. Change the position of the throw-out antenna until the reception for both bands (FM and DAB+) is optimal.
3. Then fix the loose end with tape or a nail.
  - Of course, you can also connect an active room or roof antenna for DAB/FM to the DAB/FM jack (**17**).

## ⚠ CAUTION

### Risk associated with lightning strike!

- If you are using outdoor or roof antennas, be absolutely sure that the antenna system has lightning protection.
- With the enclosed antenna adapter ⑥, you can also connect the KB 62 CR with a cable connection, but it is not possible to receive DAB+ with it.

## Inputs for source devices

### Analogue sources

The KB 62 CR offers three inputs for analogue audio sources:

- **AUX 1**  
RCA jacks (26), back side
- **AUX 2 IN**  
RCA jacks (16), front side
- **LINE IN**  
3.5 mm jack plug socket (15), front side

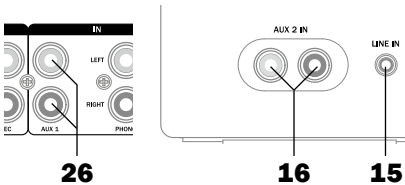

You can connect a source device with analogue sound to each of these inputs (e.g. a MP3 player or a TV set).

### Digital source

You can connect the optical sound output of a source device to the OPTICAL IN jack (22). You will need an optical cable with a TOSLINK plug for this. Your source device requires either an optical 3.5 mm plug or also a TOSLINK plug.

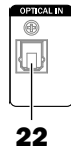

### Record player

Record players with built-in amplifier and line out connectors can be connected to one of the aforementioned analogue inputs.

All other record players must be connected to the PHONO input (25). The GROUND point (24) connects the ground line of the record player.

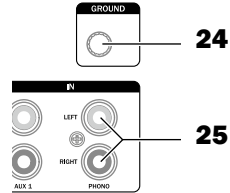

### Speaker outputs

If possible, use the enclosed cables ⑦ or a comparable high-quality, double-core speaker wire with a diameter of at least 0.75 mm<sup>2</sup> to connect the speakers. You can order corresponding cables in our webshop ([www.teufelaudio.com](http://www.teufelaudio.com)) in the “Accessories” area.

Connect the speakers to the SPEAKERS connector terminal (23).

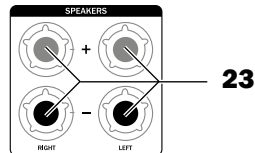

## NOTICE

**Make sure the polarity is correct! Otherwise, the sound quality will suffer.**

- Connect the like-coloured terminals.
- The strands of the speaker cables are marked with different colours or shapes.

1. Split the single wire down to approximately 30 mm and remove about 10 mm of the insulation on each strand. Twist the single wire so that no strands are protruding. Tin coating is not necessary.

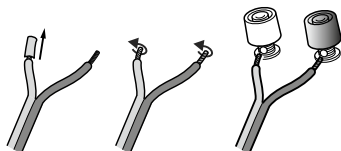

2. Turn the connector terminal (23) counterclockwise until loose.
3. Run the stripped cable end into the now visible hole.
4. Close the terminal by turning it counter-clockwise.  
The cable has now been clamped in place.

- You can also connect the speakers with pin plugs. For this, pull off the rubber caps on the connector terminals.

## Subwoofer

You can connect an active subwoofer to the SUB jack (28) with an RCA cable.

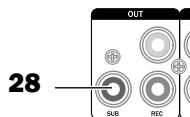

## REC OUT

The unregulated stereo audio signal is available at the jacks REC (27). You can connect an analogue recording device to it or even supply a second room with sound using active speakers or a wireless transmission system. You will need a stereo cable with RCA plugs to do so.

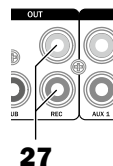

## Headphones

With the KB 62 CR, you can connect stereo headphones to two jacks:

- Jack (7) on the front side for 6.3 mm jack plugs
- PHONES jack (21) on the back for 3.5 mm jack plugs

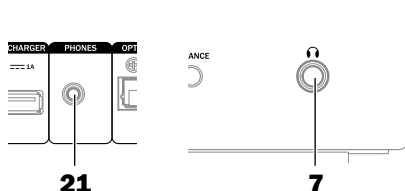



When connecting headphones to the jack (7), the speakers and the subwoofer output (28) are automatically switched off.

However, the speakers remain active for the PHONES jack (21) on the back. This jack is therefore specially intended for cordless headphones or Bluetooth transmitters, which are continually connected with the KB 62 CR.

### CAUTION



**Extended listening at high volumes may lead to hearing loss.**

- *To avoid damage to health, avoid extended listening at high volumes.*

### **Risk of injury/damage!**

- *Lower the volume before you pull the headphone plug out again; otherwise, the speakers may emit unexpected high sound pressure. This could injure your hearing or damage the device.*

## **Mains connection**

1. If necessary, ensure that the main power switch POWER (29) is switched off (“OFF” position).

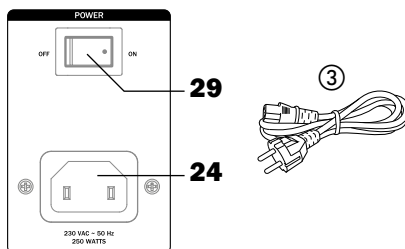

2. Insert the IEC power plug of the mains cord (3) into the POWER jack (30).
3. Insert the mains plug in a mains power socket (230 V ~ /50 Hz).

# Basic Functions

## Activating and deactivating

- Use the main power switch **POWER (29)** to switch the KB 62 CR off (“OFF” position) and to standby (“ON”). When in standby, the **POWER button (1)** will be illuminated in red.
- Turn the KB 62 CR on or to standby with the **POWER button (1)** or **⏻ (49)**. After switching the device on, the last active audio source and volume will be set.
- If the KB 62 CR does not receive an audio signal for more than 20 minutes, it will automatically switch to standby.

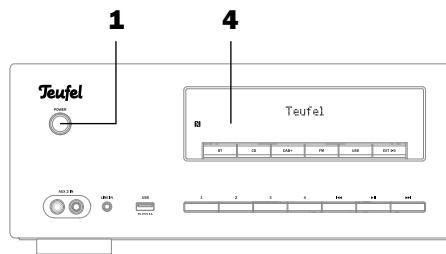
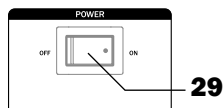

## Selecting a source

On the remote control, select the source with the buttons **(32)**:

- **BT** – Bluetooth® mode (page 26)
- **CD** – CD player (page 30)
- **DAB+** – Digital radio reception (page 24)
- **OPT** – Digital audio input
- **USB** – Play audio files from USB (page 33)
- **FM** – Analogue FM radio reception (page 23)
- **PHONO** – Record player
- **AUX 1/2** – Analogue sources AUX 1 and AUX 2
- **LINE IN** – Play analogue source

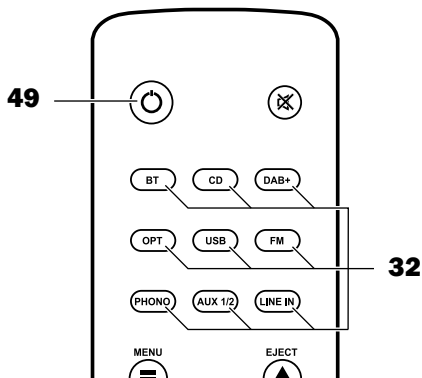

On the KB 62 CR, select the source with the buttons **(2)**:

- BT, CD, DAB+, FM and USB buttons as on the remote control.
- Push the button EXT 1-5 several times to select the sources AUX 1, AUX 2, LINE IN, OPT and PHONO one after another.

## Adjusting the volume

- Increase the volume: Turn the control dial **(6)** clockwise or push the VOLUME + button **(37)**.
- Reduce the volume: Turn the control dial **(6)** counterclockwise or push the VOLUME – button **(45)**.

The display **(4)** will show the selected volume from -69 dB to +9 dB.

**i** The volume setting of an external player often affects the volume of the KB 62 CR.

## Mute

By pushing the control dial **(6)** or the button **(31)**, you can turn the sound off and on again. The outputs SUB **(28)** and REC **(27)** will also be muted in the process.

## Adjusting the sound

Note: If there is not input for more than 3 seconds, the KB 62 CR returns to the display mode of the current audio source.

1. Push the TONE button **(9)** or the SOUND button **(43)**.  
The display **(4)** will show “Tone: Bass”.

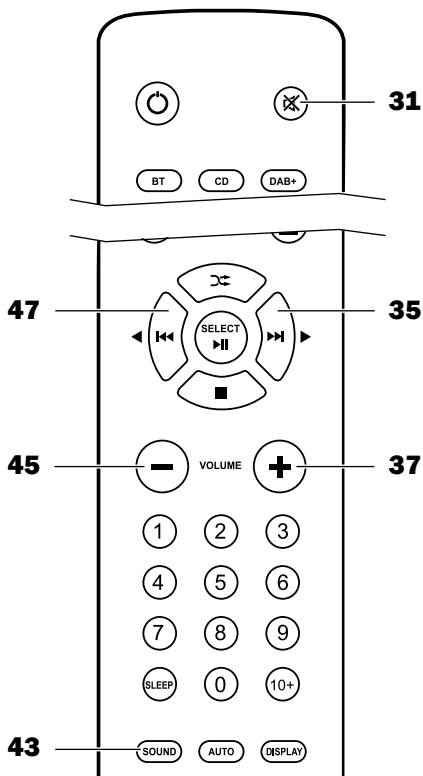
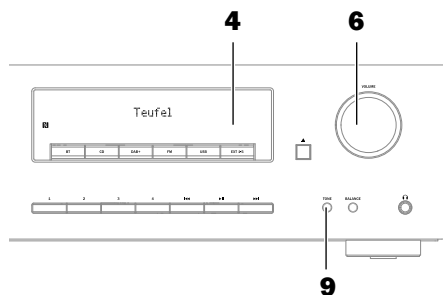
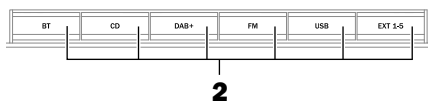

- Use the control dial (6) or the navigation buttons ◀/▶ (47/35) to set the low tones (bass tones) from “-10 dB” (decrease) to “+10 dB” (increase).
- To save the setting, push the control dial (6) or the selector button (46).
- Push the TONE button (9) or the SOUND button (43) again. The display (4) will show “Tone: Treble”.
- Use the control dial (6) or the navigation buttons ◀/▶ (47/35) to set the high tones from “-10 dB” (decrease) to “+10 dB” (increase).
- To save the setting, push the control dial (6) or the selector button (46).

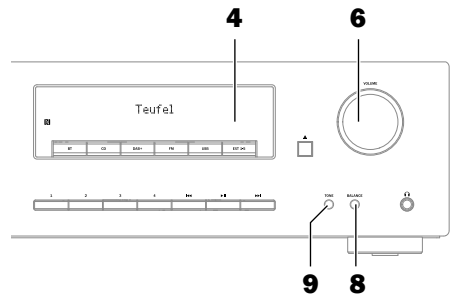

## Adjusting the balance

With the balance, you set the sound level ratio between the right and left speakers.

Note: If there is not input for more than 3 seconds, the KB 62 CR returns to the display mode of the current audio source.

- Push the BALANCE button (8) or the SOUND button (43) three times. “Balance” and the current setting will be shown on the display (4) as a bar chart.
- Use the control dial (6) or the navigation buttons ◀/▶ (47/35) to set the balance to perfectly suit your listening position.
- To save the setting, push the control dial (6) or the selector button (46).

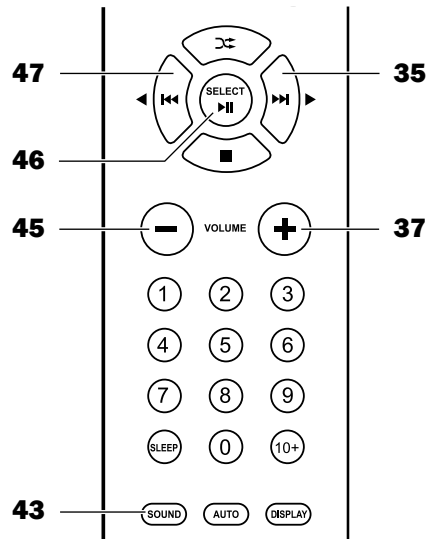

## Crossover frequency

With the crossover frequency (cross-over), you determine the frequency up to which the subwoofer operates – higher tones will be passed on to the stereo speakers.

With the SUB LOW PASS FILTER **(18)** control dial, you can set values from 60 to 150 Hz.

If you do not connect a subwoofer, set the control dial to the “NO SUB” position – as a result, all sounds will be played through the stereo speakers.

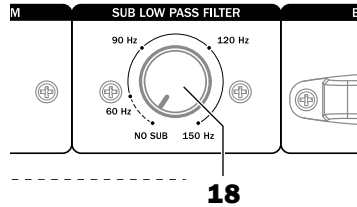

## Menu

You can perform the following functions via the menu:

- Adjust the brightness of the display **(4)**,
- reset the KB 62 CR to the default settings,
- load new system software,
- access the version of the installed system software.

1. To access the menu, push the MENU button **(48)**.  
The first menu item “VFD Brightness” will appear on the display **(4)**.

2. Select the desired menu item with the navigation buttons **◀/▶** **(47/35)** or with the skip buttons **◀◀/▶▶** **(12/10)**.

3. Use the SELECT button **(46)** or the **▶▶** button **(11)** to access the menu item.

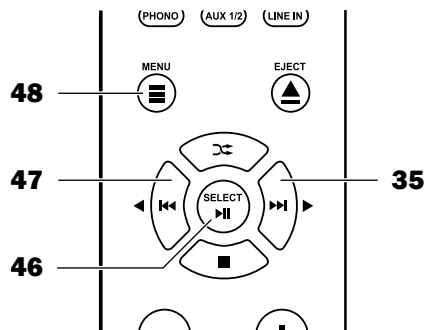
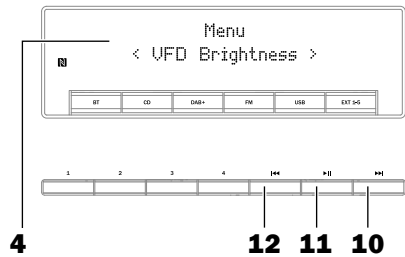

## Adjusting the display brightness

VFD Brightness menu item:

4. Set the desired brightness with the navigation buttons ◀/▶ (47/35) or with the skip buttons ⏪/⏩ (12/10).  
Possible values: 20–100 % in 20 % increments.
5. Confirm the new value with SELECT (46) or the ▶|| button (11).

## Resetting the KB 62 CR to the default settings

Factory Reset menu item: This clears all station memory slots and all modified settings.

4. Select the option with the navigation buttons ◀/▶ (47/35) or with the skip buttons ⏪/⏩ (12/10):  
<Yes> – default settings  
<No> – cancel
5. Confirm the selected option with the SELECT button (46) or the ▶|| button (11).  
The KB 62 CR will switch off if you select “Yes.” Once you have switched the device on again, the default settings will be restored.

## Loading new system software

System Update menu item:

4. Download the new system software from our website  
[www.teufelaudio.com/software-updates.html](http://www.teufelaudio.com/software-updates.html).
5. Once downloaded, unpack the file to a USB stick (FAT32 format).
6. Insert the USB stick in the USB port (14).

7. Select the option with the navigation buttons ◀/▶ (47/35) or with the skip buttons ⏪/⏩ (12/10):  
<Yes> – load the system software  
<No> – cancel
8. Confirm with the SELECT button (46) or the ▶|| button (11).  
By selecting “Yes,” the KB 62 CR will load the new software from the USB stick.

## NOTICE

### Risk of damage!

### You must not interrupt this process!

- *Do not disconnect the KB 62 CR from the power supply and do not disconnect the USB stick.*
9. The KB 62 CR will switch off once the software has been installed.
  10. Pull out the USB stick.
  11. Switch the KB 62 CR back on. The new software is active.

## Accessing the version of the system software.

System Version menu item:

Based on the version shown here (e.g. “V1.07”), you can determine whether new system software is available on our website  
[www.teufelaudio.com/software-updates.html](http://www.teufelaudio.com/software-updates.html).

## Leaving the menu

To leave the menu, push the MENU button (48) several times until the normal indicator appears again on the display.

# Radio Mode

The radio can receive analogue and digital stations within the following ranges:

- **FM:** Analogue from 87.5 to 108 MHz, RDS mode is possible.
- **DAB/DAB+:** Digital in band III from 174.160 to 239.200 MHz (block 5A to 13F) as well as in L band from 1452.192 to 1478.640 MHz.

## FM

Push the FM button **(2/32)** to activate the analogue radio as the source.

## Setting the radio stations

You can set the receiving frequency with the navigation buttons **◀/▶ (47/35)** or with the skip buttons **⏪/⏩ (12/10)**:

- Automatic: Pushing the button for approx. one second initiates station scanning in the desired direction (then release the button) until the radio turns to the next station with sufficient transmission power.
- Manual: Each time you tap the button, the frequency will be increased or decreased by 0.05 MHz.

The set frequency is shown on the display **(4)**.

If the station transmits an RDS signal, the name of the station and, if applicable, the radio text will appear on the display **(4)** after a few seconds.

You can use the DISPLAY button **(40)** or the button **▶|| (11)** to switch the display of the RDS information on the bottom line of the display **(4)** between station name, radio text, time and programme type.

In stereo mode, you may experience noticeable noise with weak stations. In this case, switch to mono mode by pushing and holding (approx. one second) the SOUND button **(43)** or the control dial **(6)**.

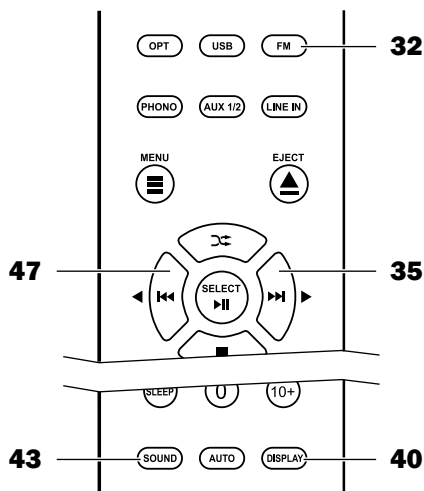
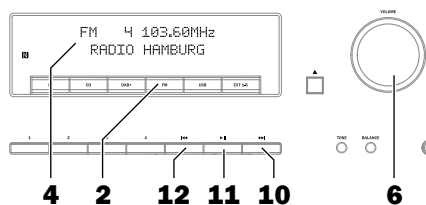

## DAB/DAB+

Push the DAB+ button (**2/32**) to activate the digital radio as the source.

DAB station scanning will automatically start the first time you access DAB. The progress of the scan will be shown on the display.

- If necessary, you can activate the scan at any time by pushing the AUTO button (**41**).

Once station scanning ends, the first station that is found will be played.

On the display, you will see the name of the station and under it, the current song being played. By tapping the buttons **▶|| (11)** or **DISPLAY (40)**, you can display further information in sequence: ensemble (station package), time/date, signal strength, programme type, block/frequency and sampling rate.

### Setting a station

You can switch between the stations that were found using the navigation buttons **◀/▶ (47/35)** or the skip buttons **◀◀/▶▶ (12/10)**.

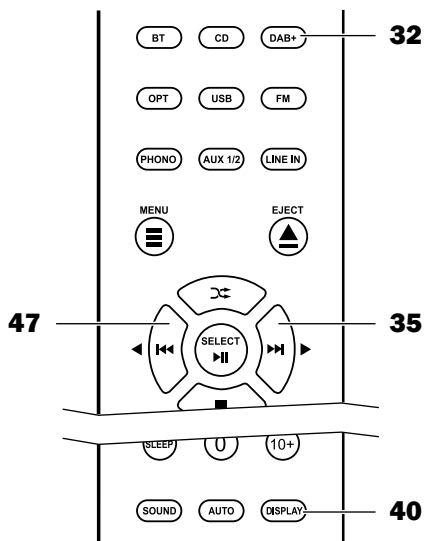
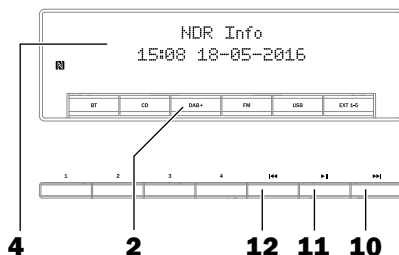



## Station memory

The KB 62 CR can save 40 stations to FM and DAB each. You can conveniently select the saved stations.

### Presetting stations manually

- Setting a desired station.
- Single-digit memory slots (1–9):  
Push and hold the number button 1...0 (**38**) with the number of the desired memory slot for approx. one second.
- Double-digit memory slots (10–40):  
Push and hold the 10+ button (**39**) for approx. one second.  
The notice “M – –” or “Memory – –” will appear on the display.  
Enter the desired double-digit memory slot number using the number buttons 1...0 (**38**).

The notice “Stored Preset x” will appear on the display (the slot number will appear instead of “x”).  
The station has now been saved.

### Only FM: Saving stations automatically

**Notice:** All saved FM stations are deleted in the process.

- Push the AUTO button (**41**) or FM button (**2**) for approx. one second.
- Confirm automatic saving with the SELECT button (**46**).
- Station scanning will start. The radio will search for stations with adequate transmission power and automatically save them. Once all 40 memory slots are occupied or the end of the frequency band has been reached, the station scan will stop and switch to the last station found.

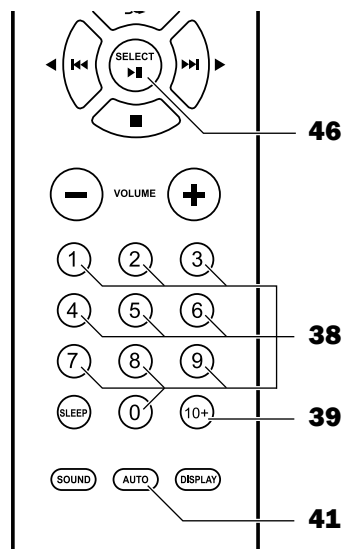
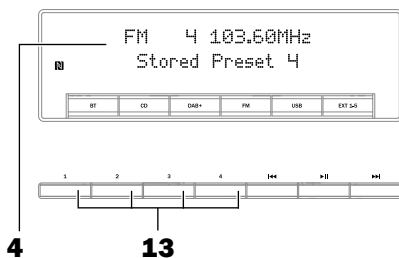

### Selecting stations from the memory

You can access the saved stations in slots 1 to 9 directly with the number buttons 1...0 (**38**); slots 1 to 4 can also be accessed via the station buttons (**13**).

With the station slots 10 to 40, first tap the 10+ button (**39**) and then enter the desired double-digit memory slot number with the number buttons 1...0 (**38**).

# Bluetooth® Mode

---

Via Bluetooth®, you can wirelessly connect a compatible external player with the KB 62 CR. The audio output of your external player is then emitted by the KB 62 CR.

The Bluetooth® wireless transmission system has a range of approximately 10 metres that is limited by walls and furnishings. If the connection is cut off, the KB 62 CR will attempt to re-establish a connection until you select another source.

## NOTICE

- *Only use the Bluetooth® function in locations where wireless radio transmission is allowed.*
- *Please keep in mind that the Bluetooth® behaviour may differ depending on the external player's operating system.*

## Bluetooth® options

Depending on the device type, your external player/smartphone may also have a menu for Bluetooth® options such as media playback. Here you can activate and deactivate the desired options. You can find more information about the Bluetooth® options in the user manual for your external player/smartphone.

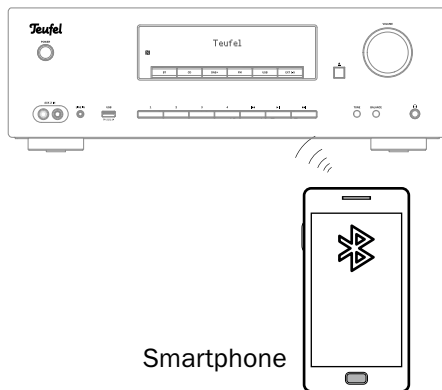

## Pairing

To play the audio of your external player on your KB 62 CR via Bluetooth®, you must first connect the devices with each other. The technical term for this is “pairing.” The KB 62 CR provides manual and automatic pairing via NFC®.

### Manual pairing

1. Turn on the Bluetooth® function on your external player (e.g. smart-phone).
2. Use the BT button **(2/32)** to select the “Bluetooth” input on the KB 62 CR. The message “BT Input Mode” will appear on the display **(4)**.
3. If the KB 62 CR is not connected to an external player, pairing will start automatically and the message “Pairing” will appear on the display **(4)**.  
Otherwise push the BT button **(2/32)** and hold it down for approx. three seconds to start the pairing process.
4. Let your external player/your smart-phone scan for Bluetooth® devices. You will find more information about this in the user manual of your external player.  
After the search run, the “Teufel KB 62” should also be shown in the list of detected devices.
5. Select “Teufel KB 62” from the list of detected devices.
6. If your external player asks for a code, enter “0000” (four zeros).

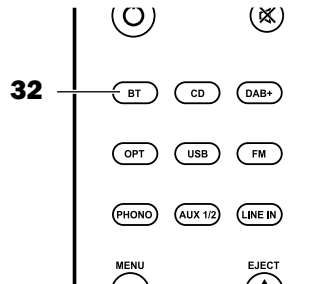
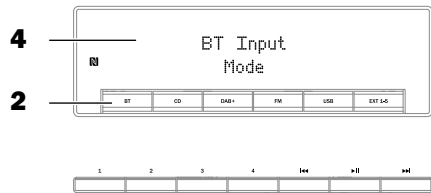

Pairing is now complete and your KB 62 CR will now act as a Bluetooth® playback device. The KB 62 CR will now play back all sounds that would otherwise be played by your external player/smartphone.

## Pairing via NFC®

NFC® (Near Field Communication) is a transmission standard for the wireless exchange of data over short distances. Your KB 62 CR can create a connection to a compatible external player via NFC®.

1. Switch the NFC® function on your source device on (Bluetooth® does not have to be turned on on the source device).
2. Hold your source device close to the NFC® contact zone  on the front side of the KB 62 CR (see fig. right). After a short time, you will be asked to allow the NFC connection.
3. Confirm the request on your source device.  
Pairing is now complete and your KB 62 CR will now act as a Bluetooth® playback device. The KB 62 CR will now play back all sounds that would otherwise be played by your source device/ smartphone.

## Restoring the connection with a paired external player

If your KB 62 CR was previously connected to the external player, it is no longer necessary to switch it to pairing mode to connect again. Simply selecting it on your external player from the list of paired devices is enough.

## Interruption of connection

If your KB 62 CR moves out of the range of your external player, the Bluetooth® connection will be interrupted. The connection will be re-established automatically when you are back within range.

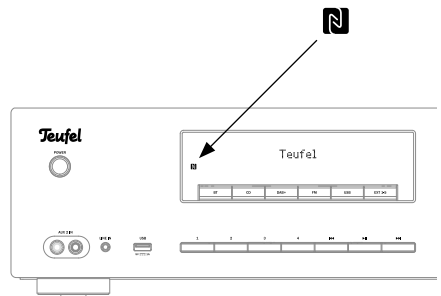

## Playback

**i** The volume setting of the external player affects the volume of the KB 62 CR.

1. Use the BT button (**2/32**) to select Bluetooth® as the source.
2. Turn on the Bluetooth® function on your source device.
3. Start playback on your source device.

Depending on the source device, you can also control playback with the KB 62 CR:

- Interrupt/continue playback: Tap the **▶||** button (**11**) or **SELECT/▶||** (**46**).
- Play next track: Tap the **▶▶** button (**10/35**).
- Play the track or chapter from the beginning: Tap the **◀◀** button (**12/47**).
- Play the previous track or previous chapter: Tap the **◀◀** button (**12/47**) twice.

Otherwise, you can control playback on your source device.

- If your source device is a smart-phone, the Bluetooth® connection will be interrupted in the event of an incoming call and you can make phone calls as usual. After finishing your phone call, the sounds will once again be diverted and played back by your KB 62 CR.
- If your Bluetooth® source device has a USB charging cable, you can connect it to the USB ports (**14**) or (**20**) for supplying power.

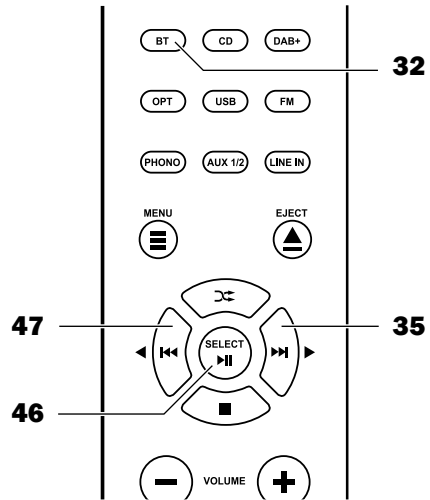
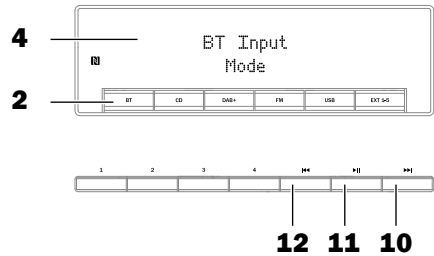

## Terminating the connection

To terminate the Bluetooth® connection:

- deactivate the Bluetooth® function on your external player/smart-phone.
- or push and hold the BT button (**2/32**) for approx. 3 seconds to terminate the pairing.

# CD Mode

Only use commercially-available CDs carrying one of the adjacent symbols.

The KB 62 CR can read normal CDs with a diameter of 80 and 120 mm as well as music files in the audio CD, MP3, M4A and WMA formats saved on them.

CDs burnt on a home system can normally be read but an excessively high burn speed or defective blank discs can cause problems.

## CAUTION

### Health hazard!



Operating the device when the housing is open will cause an invisible or visible laser beam to be emitted.

- Do not look into the beam, even if you are using optical instruments.

## NOTICE

### Risk of damage!

- Never insert multiple CDs on top of each other.
- Do not insert anything other than CDs.

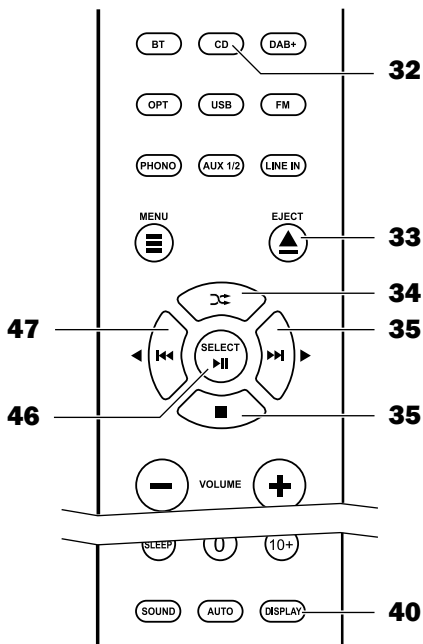
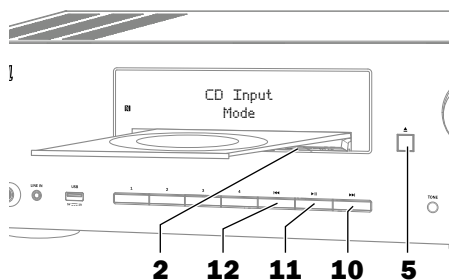

## Disc playback

1. Select the CD drive as the source with the CD button **(2/32)**.
2. Push the **▲** button **(5/33)**. The source buttons **(2)** will fold down and the CD tray will eject to the front.
3. Insert the CD carefully into the depression inside the CD tray with the printed side facing up.  
**Notice:** The CD tray will automatically close after approx. 60 seconds of inactivity.
4. Push the **▲** button **(5/33)** or the SELECT/▶|| button **(46)**. The CD tray will close and the unit will read the CD. The message "Reading" will appear on the display. Playback will automatically start after a few seconds. You will see the number of the track, the elapsed time and (if present) the name of the track on the display.
  - You can use the DISPLAY button **(40)** to access more information on the track.
  - You can access a certain track by entering its number with the number buttons 1...0 **(38)**. For track numbers above 9, first tap the 10+ button **(39)** and then enter the desired double-digit track number with the number buttons 1...0 **(38)**.
  - Interrupt/continue playback: Tap the ▶|| button **(11)** or SELECT/▶|| **(46)**.

- Switch to the next folder/directory (if present): Push the ▶|| button **(11)** or SELECT/▶|| **(46)** for one second.
- Play next track: Tap the ▶▶| button **(10/35)**.
- Play the track or chapter from the beginning: Tap the |◀◀ button **(12/47)**.
- Play the previous track or previous chapter: Tap the |◀◀ button **(12/47)** twice.
- Fast track playback: Push and hold the |◀◀ button **(12/47)** or ▶▶| **(10/35)**. Playback will occur at approx. 10 times the normal speed; the elapsed time for the track will appear on the display **(4)**. To resume normal playback, release the button.
- Stopping playback: Push the ■ button **(36)**.

### Repeat/random playback:

Access the following functions one after another with the **⏮** button **(34)**:

- REPEAT OFF – normal playback.
- REPEAT ONE – the current track will be repeated endlessly.
- REPEAT ALL – all tracks on the CD will be played back in order. Afterwards, playback restarts with the 1st track.
- REPEAT DIR – all tracks in the current folder/directory on the data CD will be endlessly played back in order.
- SHUFFLE ALL – all tracks on the CD will be played back in random order, playback will then stop.

- SHUFFLE DIR – all tracks in the current folder/directory on the data CD will be played in random order, playback will then stop (depending on the used playback media).
- SHUFFLE ALL REP – all tracks will be played endlessly in random order.
- SHUFFLE DIR REP – all tracks in the current folder will be endlessly played in random order.

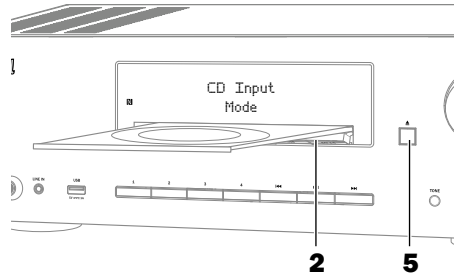

## Ejecting the disc

1. Push the ▲ button (5/33). The source buttons (2) will fold down and the CD tray will eject to the front.
2. Carefully remove the CD.
3. Push the ▲ button (5/33). The CD tray will close. The CD tray will automatically close after approx. 60 seconds of inactivity.

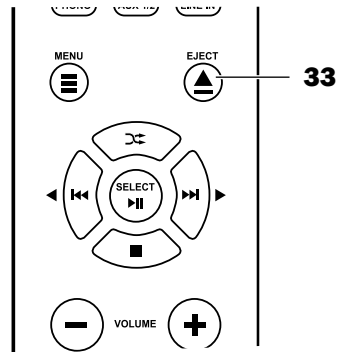



# USB Mode

Your KB 62 CR has two USB ports, each supplying 5 volts with 1 amp (also in standby):

- The back USB CHARGER port (**20**) serves solely to supply power or charge USB devices and cannot read any data.
- The front port (**14**) can read USB memory sticks and USB hard drives with the specifications 1.0 to 3.0 in the FAT16/FAT32 format and play back music files saved on it in the MP3, M4A and WMA formats.

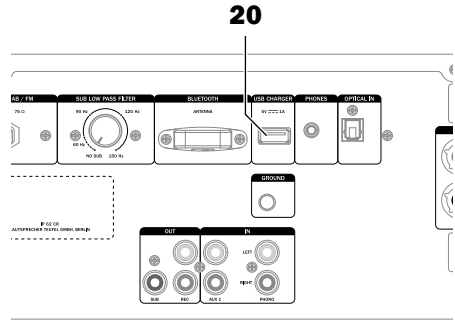

## Connecting and playing back a USB device

1. Use the USB button (**2/32**) to select the USB device as the source.
2. Insert the plug of your USB device into the USB port (**14**). The plug only fits the jack in one orientation.
3. The KB 62 CR will read the USB device. The message “Reading Files” will appear on the display. After a short time, the number of readable files will be shown. If no readable files are found on the USB stick, “No Files” will appear on the display.

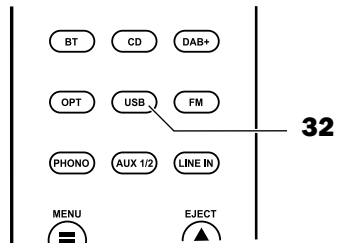
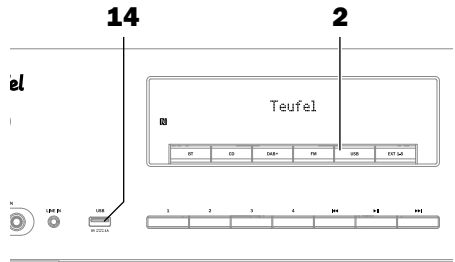

- Start playback: Tap the **▶||** button **(11)** or SELECT/▶|| **(46)**. You will see the number of the track, the elapsed time and (if present) the name of the track on the display.
- You can use the DISPLAY button **(40)** to access more information on the track.
- You can access a certain track by entering its number with the number buttons 1...0 **(38)**. For track numbers above 9, first tap the 10+ button **(39)** and then enter the desired double-digit track number with the number buttons 1...0 **(38)**.
- Interrupt/continue playback: Tap the **▶||** button **(11)** or SELECT/▶|| **(46)**.
- Switch to the next folder/directory (if present): Push the **▶||** button **(11)** or SELECT/▶|| **(46)** for one second.
- Play next track: Tap the **▶▶|** button **(10/35)**.
- Play the track or chapter from the beginning: Tap the **◀◀|** button **(12/47)**.
- Play the previous track or previous chapter: Tap the **◀◀|** button **(12/47)** twice.
- Fast track playback: Push and hold the **◀◀|** button **(12/47)** or **▶▶|** **(10/35)**. Playback will occur at approx. 10 times the normal speed; the elapsed time for the track will appear on the display **(4)**. To resume normal playback, release the button.
- Stopping playback: Push the **■** button **(36)**.

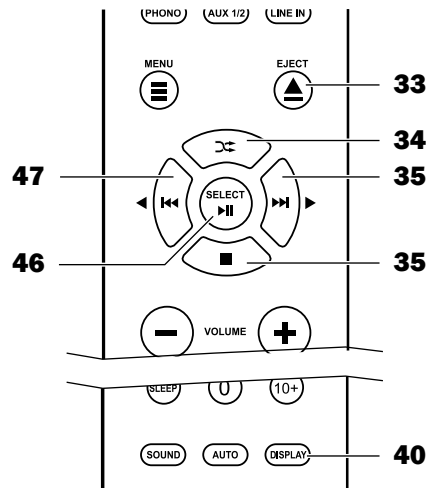
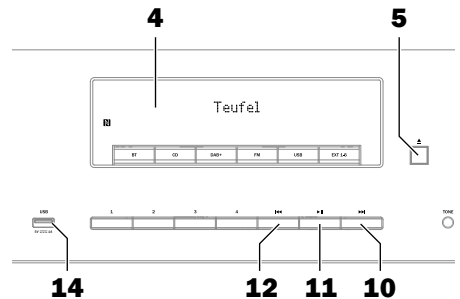

### Repeat/random playback:

Access the following functions one after another with the  button **(34)**:

- REPEAT OFF – normal playback.
- REPEAT ONE – the current track will be repeated endlessly.
- REPEAT ALL – all tracks on the CD will be played back in order. Afterwards, playback restarts with the 1st track.
- REPEAT DIR – all tracks in the current folder/directory on the data CD will be endlessly played back in order.
- SHUFFLE ALL – all tracks on the CD will be played back in random order, playback will then stop.
- SHUFFLE DIR REP – all tracks in the current folder will be endlessly played in random order.

### Removing the USB device

#### NOTICE

#### Risk of damage!

– *Never remove the USB device while the KB 62 CR is still accessing it!*

1. End playback.
2. Push the  button **(5/33)**.  
The message "Safe to Remove" will appear on the display **(4)**.
3. Pull the USB device out of the USB port **(14)**.

# Sleep Function

---

This function allows the KB 62 CR to switch itself off after a preset period of time.

1. Start the desired playback.
2. Push the SLEEP button (**44**). The display will show the message "Sleep Off".
3. Press the SLEEP button (**44**) again to select the desired time to switch off between 10 and 90 minutes in increments of 10 minutes. The "Sleep Off" setting deactivates the sleep function.

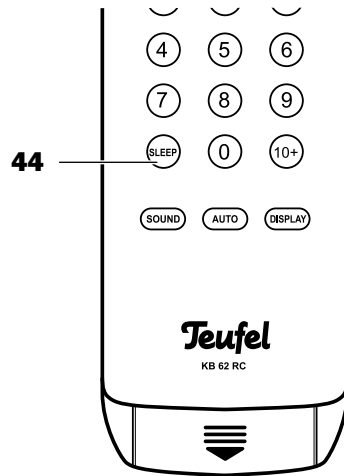

# Care And Cleaning

---

## **NOTICE**

### **External influences may damage or destroy the device.**

- *If the device is to be left unattended for a prolonged period of time (e.g. during a vacation) or if a thunderstorm is forecast, pull the mains plug out of the socket. Otherwise, sudden overvoltage could cause a defect.*
  - *If possible, only use plain water without any additives. In case of stubborn marks, a mild soap solution may be used.*
  - *Do not use caustic cleaning products, white spirit, thinners, petrol or similar under any circumstances. Such cleaning agents may damage the delicate surface of the housing.*
- Ideally, you should remove dust or small amounts of dirt with a dry, smooth leather cloth.
  - Use a damp cloth to rub off stubborn dirt. Make sure that no liquid penetrates the housing.
  - Then immediately wipe the damp surfaces off with a soft cloth without applying pressure.

# Troubleshooting

The following advice should help you to solve problems. If this does not help, you will find useful information in the detailed FAQs on our website. Otherwise, please contact our hotline (see page 4). Take note of the warranty instructions.

Problem	Possible cause	Solution
No function.	No power supply.	Check the function of the socket with another device.
No sound.	The wrong source has been selected.	Select the correct source (see "Selecting a source" on page 18).
	The volume has been set too low.	Increase the volume.
	The volume of the external player has been set too low.	Carefully increase the volume of the external player.
	Speaker cable not stripped.	Properly connect the speaker (page 15).
No sound in Bluetooth® mode.	No Bluetooth® connection.	Establish a connection (see page 27).
	KB 62 CR has not been selected as the output device.	On the external player, select "Teufel KB 62" as the Bluetooth® output device.
	Bluetooth® connection impaired by another radio system (e.g. cordless telephone, Wi-Fi).	Set up the KB 62 CR and/or external player in another location. Move to another room to test.
DAB+ reports "No signal" or "Service Not Available".	No or only very weak DAB reception.	Check the antenna. If necessary, use an active room antenna or outside antenna (see page 14).

Problem	Possible cause	Solution
When connecting a USB device, “Not supported” appears on the display.	The file format of the USB device is not supported. The KB 62 CR supports the FAT16 and FAT32 file systems.	Use a USB device with a suitable file system.
USB device is not recognised.	The rear USB port <b>(20)</b> is used, which is only intended for the supply of power/charging.	Only use the front USB port <b>(14)</b> to play back audio files.
	The power consumption of the connected USB device is too high (> 1 A).	Connect an additional power supply to the USB device.
The subwoofer hums.	The KB 62 CR is connected to a different power circuit from the rest of the system.	Connect the KB 62 CR to the same power circuit.
	The hum is due to line disturbance.	Buy a line filter and connect all devices to it.
	The humming is caused by a multiple socket strip.	Use a different multiple socket strip or connect the KB 62 CR directly to the wall socket.
Playback is noisy.	Generally speaking, the KB 62 CR is a very low-noise system. A device with very high resolution in the high range area can expose the poor quality of a signal source (e.g. from MP3 files).	Make sure that the external player emits a clear signal to the KB 62 CR.

# Index

---

## A

Antenna adapter 14

## B

Bass tones 19

Batteries

dispose 5

insert 13

Bluetooth 26

transmitter 17

Brightness

Display 21

## C

Cable connection 14

Call 29

Compact Disc 30

Cordless headphones 17

Crossover 21

Crossover frequency 21

## D

DAB+ 23

Default settings 21

Display 21

DVD

eject 32

## F

Files

Music 30, 33

Firmware 21

FM 23

Frequency 23

## G

Ground point 15

## H

Hard-drives 33

Headphones 16

## M

Main power switch 18

Mains cord 17

Menu 21

Mono 23

Mute 19

Muting 19

## N

NFC 28

Number buttons 25, 31

## O

Optical 15

## P

Pack contents 9

Pairing 27

Phone call 29

Playback 31, 34

Power supply

USB 29, 33

## R

Radio 23

text 23



Radio stations  
    save 23  
    selecting stations from the memory  
    23  
Random playback 31, 35  
RDS 23  
Receiving frequency 23  
Recording device 16  
Record player 15  
Remote control 13  
REPEAT 31  
Reset 21

## **S**

Selecting stations from the memory  
25  
Setting the radio stations  
    automatically 23  
    manually 23  
SHUFFLE 31  
SLEEP 36  
Smartphone 27, 29  
Sound control 19  
Sound level ratio 20  
Source devices 15, 18  
Speaker 15, 17, 21  
Standby 18  
Station 25  
Station buttons 25  
Subwoofer 21  
    active 16  
System software 21

## **T**

TOSLINK 15  
Track  
    repeat 31, 35  
Treble tones 20  
TV set 15

## **U**

Update 21  
USB stick  
    insert 33  
    play back 33  
    remove 35

## **V**

Volume 19, 29

## **W**

Wireless transmission system 16

# Technical Data

---

Dimensions (W × H × D):	435 × 140 × 296 mm
Weight:	approx. 8 kg
Operating voltage:	230V~, 50/60 Hz
Max. power consumption	250 watts

You can find further technical data on our website.  
Technical changes reserved!

## Declaration of Conformity

---

 Lautsprecher Teufel GmbH hereby declares that this product is in accordance with the requirements of directives 2014/30/EU, 2014/35/EU and 2014/53/EU as long as it is installed and used according to the manufacturer's instructions. The full text of the EU Declaration of Conformity is available at the following Internet address:  
[www.teufelaudio.com/declaration-of-conformity.html](http://www.teufelaudio.com/declaration-of-conformity.html)

The following radio frequency bands and radio transmitters are used in this product:

Radio network	Frequency bands in Mhz	Transmitter power mW/dBm
FM-tuner	87.5–108	–
DAB-tuner	174–230	–
Bluetooth	2400–2483.5	2.5/4
NFC	13.56	–



# Teufel

Please contact our customer service department with any questions, suggestions or complaints:

Lautsprecher Teufel GmbH  
BIKINI Berlin  
Budapester Str. 44  
10787 Berlin (Germany)

Phone 00800 - 200 300 40 (toll-free)  
Fax: +49 (0)30 / 300 930 930  
Service: [www.teufelaudio.com/service](http://www.teufelaudio.com/service)  
Contact: [www.teufelaudio.com/contact](http://www.teufelaudio.com/contact)

No responsibility is assumed for the correctness of this information.  
Technical changes, typographical errors and other errors reserved.

Manual No. 94142 GB 20171103