

Technical Description And User Manual

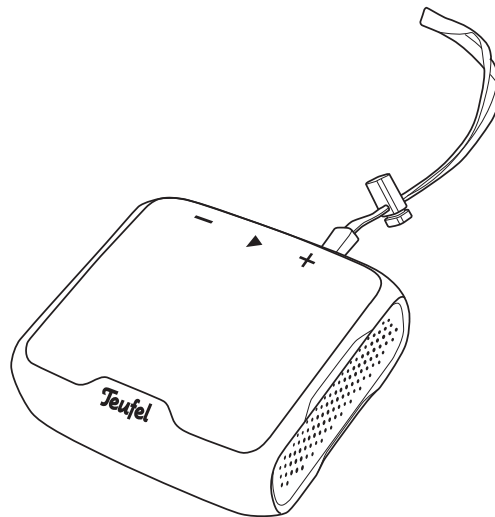

BOOMSTER GO

Water-resistant active Bluetooth®
speaker with True Wireless Stereo

Teufel

Contents

General Information	3	Setup.....	17
Notice	3	Location tips.....	17
Trademarks	3	PA tripod	18
Original packaging	3	Wrist strap	18
Complaints	4	Operation	19
Contact	4	Activating and	
Proper use	5	deactivating.....	20
For your safety	6	Volume.....	20
Signal terms	6	Bluetooth®	21
Safety notes	7	TWS mode	25
Package contents.....	12	Care and cleaning	26
Controls and		Troubleshooting.....	27
connections	12	Technical data	29
The rechargeable		Declaration of	
battery.....	14	conformity.....	30
Charging the battery ...	15		
Charge level.....	16		

General Information

Notice

The information in this document may change without prior notice and in no way constitutes any liability on the part of Lautsprecher Teufel GmbH.

No part of this user manual may be reproduced in any form or be broadcasted in any way electronically, mechanically, by photocopy or recording without the written permission of Lautsprecher Teufel GmbH.

© Lautsprecher Teufel GmbH

Version 1.0

November 2019

Trademarks

© All trademarks are the property of their respective owners.

 **Bluetooth**® The Bluetooth® word mark and Bluetooth® symbol are registered trademarks of Bluetooth SIG, Inc. and any use by Lautsprecher Teufel is licensed.

Original packaging

If you wish to exercise your eight-week right of return, we ask that you be absolutely sure to hold onto the packaging. We can only accept the return of the speakers WITH THE ORIGINAL PACKAGING.

Empty boxes are not available!

Complaints

In case of a complaint we will need the following information to process your enquiry:

1. Invoice number

Can be found on the sales slip (enclosed with the product) or on the order confirmation received as a PDF document.

2. Serial number or batch number

Located on the bottom or back of the device.

Thank you for your support!

Contact

Please contact our customer service department with any questions, suggestions, or complaints:

Lautsprecher Teufel GmbH

**BIKINI Berlin
Budapester Str. 44
10787 Berlin (Germany)**

Telephone:
00800 200 300 40
(toll- free)

Fax:
+49 30 300 930 930

Online support:
[www.teufelaudio.com/
service](http://www.teufelaudio.com/service)

Contact form:
[www.teufelaudio.com/
contact](http://www.teufelaudio.com/contact)

Proper use

The speaker, which is water-tight according to IP X7, is designed for the playback of music and speech from an external player via Bluetooth®.

Only use the speaker as described in this user manual. Any other use will be deemed as not in accordance with the instructions and may lead to damage of property or even persons.

The manufacturer accepts no liability for damage caused by improper use.

The speaker is intended for private use.



Before operating the speaker, please read the safety notes and user manual carefully. Only in this way, can you ensure that all functions are used in a safe and reliable manner. Store the user manual in a safe place and also be sure to pass it on to any subsequent owner.

For your safety

Signal terms

You can find the following signal terms in this user manual:

WARNING

This signal term indicates a moderate risk, which, if not avoided, may result in death or severe injury.

CAUTION

This signal term indicates a low risk, which, if not avoided, may result in minor or moderate injury.

NOTICE

This signal term warns you of potential damage.

Safety notes

This chapter contains general safety notes which you should always observe to protect yourself and third parties. Also observe the warning notes in each chapter of this user manual.

WARNING

Touching live parts can result in severe injury or death.

- When connecting the device, make sure that the correct voltage is present. You can find more information about this on the rating plate.
- Check the device regularly for damage. Do not use the device if its housing is defective or exhibits other visible damage.
- This device can only be completely disconnected from the grid by pulling the USB charger. Therefore, make sure that the charger is always easily accessible.
- If the device emits smoke, smells burnt or produces unusual sounds, immediately disconnect it from the mains and do not operate it further.
- Never open the device housing. Repairs may only be carried out by an authorised specialist workshop. Only parts that match the original specifications may be used.
- Only use the accessory products specified by the manufacturer.
- Never modify the device. Unauthorised modifications may affect the safety and functionality.

⚠ WARNING

An unsuitable setup location may result in injury and damage.

- *If the speaker is not securely mounted, do not use it in vehicles, in unstable locations, on wobbly tripods or furniture, on underdimensioned brackets etc. The speaker may tip or fall over and cause injury to persons or be damaged itself.*
- *Position the speaker in such a way that it cannot be knocked over inadvertently and make sure that the cables do not pose a tripping hazard.*
- *Do not use the device in environments where there is a risk of explosion.*
- *Only use the Bluetooth® function in locations where wireless radio transmission is allowed.*

⚠ WARNING

Children can become trapped in the plastic wrapping when playing and suffocate.

- *Do not allow children to play with the device or the plastic wrapping. There is a danger of suffocation.*
- *Never allow children to operate electrical equipment unsupervised.*

⚠ WARNING

Lithium rechargeable batteries can explode if handled improperly.

- *You must not heat or short circuit rechargeable batteries or dispose of them in fire.*
- *Do not expose the rechargeable batteries to direct sunlight.*
- *Do not place the speakers near heat sources (e.g. heaters, ovens, other heat generating equipment such as amplifiers etc.).*

 **CAUTION**

 **Extended listening at high volumes may lead to hearing loss.**

To avoid damage to health, avoid extended listening at high volumes.

- When the volume is set high, always keep a certain distance from the device and never place your ears directly on the speaker.
- If a speaker is set to full volume, this may produce very high sound pressure. This may have psychological consequences and also cause physical injury. Children and pets are particularly at risk. Set your signal source device volume control to a low setting before turning on the power.

 **CAUTION**

This product contains magnetic material.

- If necessary, consult your physician and ask for effects on implants such as pacemakers or defibrillators.

NOTICE

The BOOMSTER GO is watertight in depths of up to one meter.

- Normal rain and a few splashes from showering won't cause any damage, but you should avoid spraying it directly with a hose.
- If the BOOMSTER GO falls into a paddling pool, fish pond or other flat water body, nothing will happen if you recover it right away. However, the device is not suitable for prolonged diving!
- You should generally avoid contact with salt water.

NOTICE

Gross misuse and incorrect care are the main reasons for damage to high-performance rechargeable batteries.

- Avoid deep discharge of under 10 % for optimal rechargeable battery power.
- Recharge your rechargeable battery frequently.
- Store your rechargeable battery in a cool but frost-free area, ideally at 15 °C. Higher temperatures result in a higher rate of self-discharge and shorten the intervals between charges.
- Do not expose the rechargeable battery to direct sunlight or other sources of heat.
This applies in particular when charging the rechargeable battery.
- A deep discharge damages the rechargeable battery cells. The most frequent cause of deep discharge is prolonged storage or failure to use a partially discharged rechargeable battery. Only store the rechargeable battery once it is fully charged.

 **Old devices must not be disposed of with household waste!**

If the BOOMSTER GO is no longer operational, every consumer is required by law to dispose of used devices separately from household waste, e.g. at a collection point run by the communal authority/borough. This ensures that old devices are recycled in a professional manner and also rules out negative consequences for the environment.

For this reason, electrical equipment is marked with the adjacent symbol.

 **Used batteries must not be disposed of with household waste!**

Every consumer is required by law to bring all batteries and rechargeable batteries, regardless whether they contain harmful substances or not, to a collection point run by the communal authority/borough or to a retailer, so that they can be disposed of in an environmentally friendly manner.

Please only turn in batteries and rechargeable batteries which are empty!

Package contents





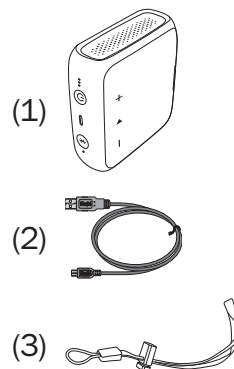

- (1) BOOMSTER GO
- (2) Charging cable (USB A to Micro B)
- (3) Wrist strap

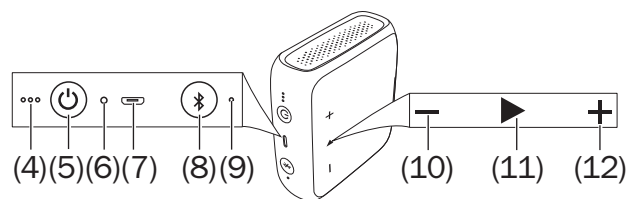
- Check that all items have been delivered and that nothing is damaged. If you find any damage, do not operate the device; instead contact our customer service department (see „Contact“ on page 4).
- Please keep the packaging for the duration of the warranty period.



Controls and connections



- (4) LED indicator for charging and rechargeable battery charge level
- (5) Push and hold  for 2 seconds: turn the device on and off, tap  during operation: display battery level with LEDs (4)
- (6) Microphone
- (7) USB micro port for the charger (not included in the package contents)
- (8) Push and hold  for 2 seconds: start Bluetooth® pairing, push and hold  for 10 seconds: clear all Bluetooth® connections
- (9) Bluetooth® LED
- (10) – decrease the volume, in case of a phone call: reject call, in case of BT playback push together with the  button (11): skip back
- (11) Tap : playback/pause, long push: activate the smartphone's voice assistant, briefly push in the event of a phone call: accept call/hang up
- (12) + increase the volume, in case of BT playback push together with the  button (11): skip forward

Bottom:

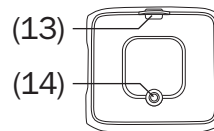

- (13) Loop for carrying strap (3)
- (14) Tripod thread (1/4" × 10 mm)

The rechargeable battery

CAUTION

Batteries (particularly lithium batteries) can explode if used improperly.

– You must not heat or short circuit rechargeable batteries or dispose of them in fire.

– Do not expose the rechargeable batteries to direct sunlight.

- Before first use, charge the rechargeable battery for approx. 3 to 4 hours.
- To do so, you can use any USB charger with the corresponding cable. A charging cable **(2)** of type USB A to micro USB is included in the package contents.

- The BOOMSTER GO charges with 5 V, 1.5 A (7.5 watts).
- The fully charged rechargeable battery provides an operating time of approx. 10 hours at medium volume.

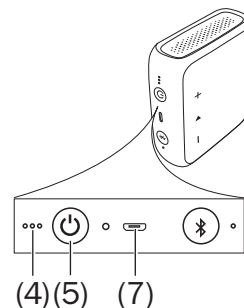

- Of course, you can also operate the BOOMSTER GO with a charger, a PC or a USB battery pack via the USB cable. As soon as the rechargeable battery is fully charged, the auto-function will deactivate the charging current – playback is not interrupted.

Charging the battery



If the device is wet, a short circuit can occur during the charging process.

- *Let the device dry completely before charging.*

The integrated Li-Ion rechargeable battery is charged as soon as the BOOMSTER GO is supplied with power from the USB micro port (7).

Three white LEDs on the rechargeable battery indicator (4) signalise the charging process:

100%	all 3 LEDs are illuminated
66-99%	2 LEDs are illuminated, one is flashing
33-65%	one LED is illuminated, 2 are flashing
<32%	Sequential light with all three LEDs

Room temperature is ideal for charging the rechargeable battery. In an excessively cold or hot environment, the rechargeable battery doesn't reach its full capacity during charging.

Charge level

You can display the battery charge level by tapping the  button (5):

66-100%	all 3 LEDs are illuminated
33-65%	2 LEDs are illuminated
11-32%	1 LED is illuminated
6-10%	Warning tone, 1 LED blinks slowly (1/second)
<6%	Warning tone, 1 LED blinks quickly (2/second)

With some smartphones, the charge level is also shown on the display.

 If the rechargeable battery charge diminishes, the BOOMSTER GO will emit short warning tones and the left LED of the rechargeable battery indicator will blink. Depending on the volume, operation will still be possible for up to 60 minutes. In this case, connect a USB charger shortly.

- To protect the rechargeable battery, the BOOMSTER GO has deep discharge protection, which switches the device off once the threshold is reached.
- In this case, the BOOMSTER GO can not be switched on again.

Setup

NOTICE

In case of very high volumes and bass-accented music, the device may move.

- *Therefore, always make sure that the device is securely positioned. There is no warranty for damages caused by falling or dropping down.*

Location tips

- Select a stable, level base.
- Select a location away from heat sources and direct sunlight.
- If applicable, lay the connector cords so that they do not pose a tripping hazard.
- Do not place any objects on the BOOMSTER GO.

You can simply place the BOOMSTER GO on a stable, level surface.

PA tripod

A threaded hole **(14)** (1/4" × 10 mm) with which you can mount the device on a photo or PA tripod is located on the bottom of the BOOMSTER GO. You can also use it for the brackets of some action cameras.

Wrist strap

You can use the wrist strap **(3)** to carry the BOOMSTER GO on your wrist with ease.

1. Push the end of the small, thin loop through the loop **(13)** completely.
2. Pull the other end of the wrist strap through the small loop.

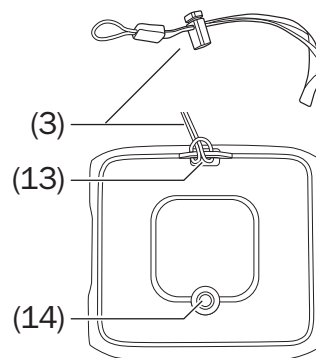

Operation

 **CAUTION**

 **Extended listening at high volumes may lead to hearing loss.**

- To avoid damage to health, avoid extended listening at high volumes.
- When the volume is set high, always keep a certain distance from the device and never place your ears directly on the speaker.

- If a speaker is set to full volume, this may produce very high sound pressure. Set your signal source device volume control to a low setting before turning on the power.

NOTICE

If the device is subjected to warm temperatures after being cold (e.g. after transport), condensation may occur inside of it.

- In this case, wait at least 2 hours before you connect and activate it.

Activating and deactivating

- To activate the device, push and hold the  button **(5)** for approx. 2 seconds.

The BOOMSTER GO is switched on with a signal tone and the LED indicator **(4)** will briefly illuminate to indicate the battery charge level.



(4) (5)

- To deactivate the device, push and hold the  button **(5)** for approx. 2 seconds.

The BOOMSTER GO is switched off with a signal tone.

Auto off

- The device will automatically switch to standby if no input signal is received for 10 minutes.

Volume

- With the **– (10)** and **+** buttons **(12)**, you can decrease or increase the volume.



(10) (12)

You can gradually adjust the volume by tapping. Pushing and holding will change the volume continuously.

Bluetooth®

Via Bluetooth®, you can connect a compatible external player and the BOOMSTER GO wirelessly. The audio output of your external player is then emitted by the BOOMSTER GO.

For smartphones with an Android or IOS operating system, you can also use the voice assistant via the BOOMSTER GO.

NOTICE

Only use the Bluetooth® function in locations where wireless radio transmission is allowed.

Please keep in mind that the Bluetooth® behaviour may differ depending on the external player's operating system.

Bluetooth® options

Depending on the device type, your external player/ smartphone may also have a number of Bluetooth® options such as media playback and call function.

You can find more information about the Bluetooth® options in the user manual for your external player/ smartphone.

Pairing

To play the audio of your external player on your BOOMSTER GO via Bluetooth®, you must first connect the devices with each other. This is called "Pairing". The BOOMSTER GO can save data from up to seven external players, which can be subsequently connected to without having to repeat the pairing process.

1. Turn on the Bluetooth® function on your external player (e.g. smartphone).

2. Push the  button **(8)** and hold it for approx. 2 seconds.

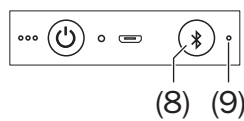

You will hear a connection tone and the Bluetooth® LED **(9)** will flash in blue.

3. Let your external player/ smartphone scan for Bluetooth® devices. You will find more information about this in the user manual of your external player. After the search run, the “BOOMSTER GO” should also be present in the list of detected devices.

4. Select “BOOMSTER GO” from the list of detected devices.

Pairing is now complete and your BOOMSTER GO will now act as a Bluetooth® playback device. The BOOMSTER GO will now play back music that would otherwise be played by your external player/ smartphone.

Playback

i The volume setting of the external player affects the volume of the BOOMSTER GO.

- Start playback on your external player.
- Pause playback: Briefly push the button **▶ (11)**.
- Continue playback: Briefly push the button **▶ (11)**.
- Play next track: Tap the buttons **▶ (11)** and **+ (12)** at the same time.
- Start the track from the beginning: Tap the buttons **▶ (11)** and **- (10)** at the same time.
- Play previous track: Tap the buttons **▶ (11)** and **- (10)** twice at the same time.



Voice assistants

Prerequisites: Present Bluetooth® connection and voice assistant on the smartphone is enabled.

To activate the assistant, push the **▶** button **(11)** for two seconds and wait until the assistant responds. Then simply speak in the direction of the microphone **(6)** of the BOOMSTER GO.

Call function

You can use the BOOMSTER GO as a hands-free device for your smartphone.

- In the event of an incoming call, your smartphone will ring and the BOOMSTER GO will also emit a ring tone. Any media playback will be paused.
- To reject the call, tap the **-** button **(10)**. The call will be ended and the caller will hear the busy signal.

- To take the call, tap the ► button **(11)**.
- Now you can answer the call with your BOOMSTER GO via the integrated microphone **(6)**.
- Push the ► button **(11)** again to end the call.

Media playback will resume.

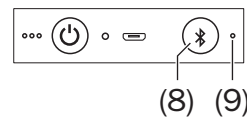
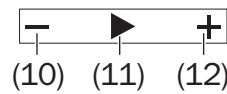
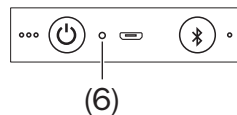

Terminating the Bluetooth® connection

To terminate the Bluetooth® connection, switch the Bluetooth® function on your external player/smartphone off.

- To delete the list of known external players, hold the ✖ button **(8)** down for approx. 10 seconds until two short signal tones can be heard.

TWS mode

“True Wireless Stereo” is a new standard for transfer via Bluetooth® with a sound quality that has not been reached to date.

You can pair two BOOMSTER GO with each other via Bluetooth® so that both devices play back the same music in stereo.

The range is approx. 10 metres. Thus, you can use two devices at the same time to supply a larger area with sound.

1. Pair the first BOOMSTER GO with your smartphone (see „Pairing“ on page 21).
2. When this pairing is complete, start TWS pairing on the first BOOMSTER GO: Push and hold the buttons ✖ **(8)** and + **(12)** simultaneously for approx. 3 seconds. The Bluetooth® LED **(9)** flashes in blue and you hear a tone.
3. Start pairing on the second BOOMSTER GO: Push and hold the button ✖ **(8)** for 2 seconds. After a short time, the two devices will connect with one another. The Bluetooth® LED **(9)** will continuously illuminate in blue on both BOOMSTER GO.
4. Now reconnect your smartphone with the first BOOMSTER GO: Select “BOOMSTER GO” from the list of detected Bluetooth devices.

Now both devices will play back the same music in stereo.

- Control playback on the first BOOMSTER GO – it will emit the left stereo channel.
- To disable TWS mode, push and hold the buttons ✖ **(8)** and – **(10)** on the first BOOMSTER GO simultaneously for approx. 3 seconds. You will hear a signal tone and the connection has been terminated.
- If you switch off one of the BOOMSTER GO, this will also disable TWS mode.

Care and cleaning

NOTICE

External influences may damage or destroy the device.

- *If the device is unattended for a prolonged period (e.g. when on vacation) or in the event of an incoming storm, disconnect the device from the charger. Otherwise, sudden overvoltage could cause the device to become defective.*
 - *Only use plain water without any additives. In case of stubborn marks, a mild soap solution may be used.*
- *Do not use caustic cleaning products, white spirit, thinners, petrol or similar under any circumstances. Such cleaning agents may damage the delicate surface of the housing.*
 - Ideally, you should remove dust or small amounts of dirt with a dry, smooth leather cloth.
 - Use a damp cloth to rub off stubborn dirt.
 - Afterwards, immediately wipe the damp surfaces off with a soft cloth without applying pressure in order to avoid lime spots.

Troubleshooting

The following advice should help you to solve problems. If this does not work, our online manual will provide help:

<https://manual.teufelaudio.com>

Problem	Possible cause/solution
No function	The rechargeable battery is empty: Recharge the rechargeable battery.
No sound	The volume has been set too low: Increase the volume.
	The volume of the external player has been set too low: Carefully increase the volume of the external player.
	No Bluetooth® connection: Establish a connection (see „Bluetooth®“ on page 21).
	BOOMSTER GO has not been selected as the output device: On the external player, select “BOOMSTER GO” as the Bluetooth® output device.
	Bluetooth® connection impaired by another radio system (e.g. cordless telephone, Wi-Fi): Move the devices causing the disturbance.

Playback of my external player is too quiet	Check the settings of your external player. After applying the latest Android and IOS updates, a limiter may be activated which reduces the output signal. This was implemented by the manufactures as a protective mechanism.
Playback is noisy	Generally speaking, the BOOMSTER GO is a very low-noise system. In the high range area, very high-resolution speaker systems can expose the poor quality of a signal source (e.g. from MP3 files). Ensure that the source is sending a clear signal to the BOOMSTER GO.
The voice assistant doesn't work	Activate the voice assistant on the smart-phone.

Technical data

Charging voltage and current	USB: 5 V / 1.5 A
Dimensions (W×H×D)	107 × 46 × 102 mm
Weight	360 g

The following radio frequency bands and radio transmitting powers are used in this product:

Frequency bands	Max. transmission power
2.4-2.4835 GHz	2.5 mW/4 dBm

You can find further technical data about the product on our website.

Declaration of conformity

CE Lautsprecher Teufel GmbH hereby declares that this product complies with the requirements of the directives 2014/30/EU, 2014/35/EU and 2014/53/EU to the extent they are installed and used in accordance with the instructions of the manufacturer. The full text of the EU declaration of conformity is available at the following Internet address:

www.teufelaudio.com/konformitaetserklaerungen.html

Teufel

Please contact our customer service department with any questions, suggestions, or complaints:

Lautsprecher Teufel GmbH
BIKINI Berlin
Budapester Str. 44
10787 Berlin (Germany)

Telephone: 00800 200 300 40 (toll- free)

Fax: +49 30 300 930 930

Online support: www.teufelaudio.com/service

Contact form: www.teufelaudio.com/contact

No responsibility is assumed for the correctness of this information.
Technical changes, typographical errors and other errors reserved.

Manual no. 197913_EN-GB_20191119